

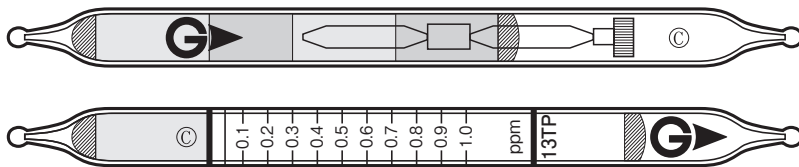

NEW tubes

Carbon disulphide No.13TP



The above tubes need GASTEC automatic air sampling pump Model GSP-501FT.

Scale range	(0.05) - 1.0 ppm
Measuring range	0.05 - 2.4 ppm
Colour change	Blue → Yellowish green
Shelf life	24 months

Methyl tert-butyl ether No.166

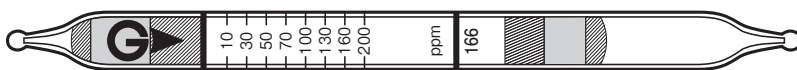

Scale range	10 - 200 ppm
Measuring range	10 - 660 ppm
Colour change	Yellow → Pale blue
Shelf life	24 months

Methyl isothiocyanate No.234L

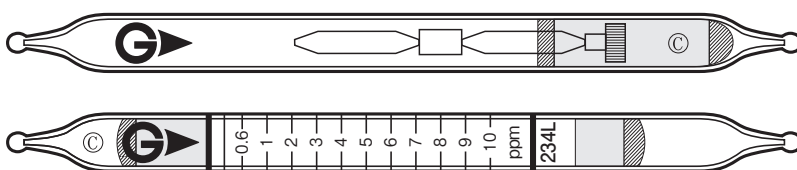

Scale range	(0.3) - 10 ppm
Measuring range	0.07 - 25 ppm
Colour change	Pink → Yellow
Shelf life	24 months

N,N-Dimethylformamide No.183TP

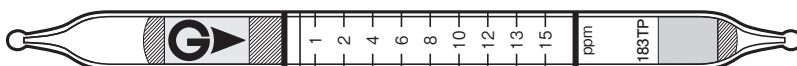

The above tubes need GASTEC automatic air sampling pump Model GSP-501FT.

Scale range	(0.5) - 15 ppm
Measuring range	0.5 - 30 ppm
Colour change	Pink → Yellow
Shelf life	24 months

Ethyl mercaptan No.72LN



No.72LN is an improved version of the existing No.72L.
This environmentally-friendly version does not contain any mercury substances.

Scale range	(0.5) - 25 ppm
Measuring range	0.15 - 57.5 ppm
Colour change	Yellow → Pink
Shelf life	24 months

PREPARATION

Inspecting the pump model GV-100/110 before measurement (air leak check)

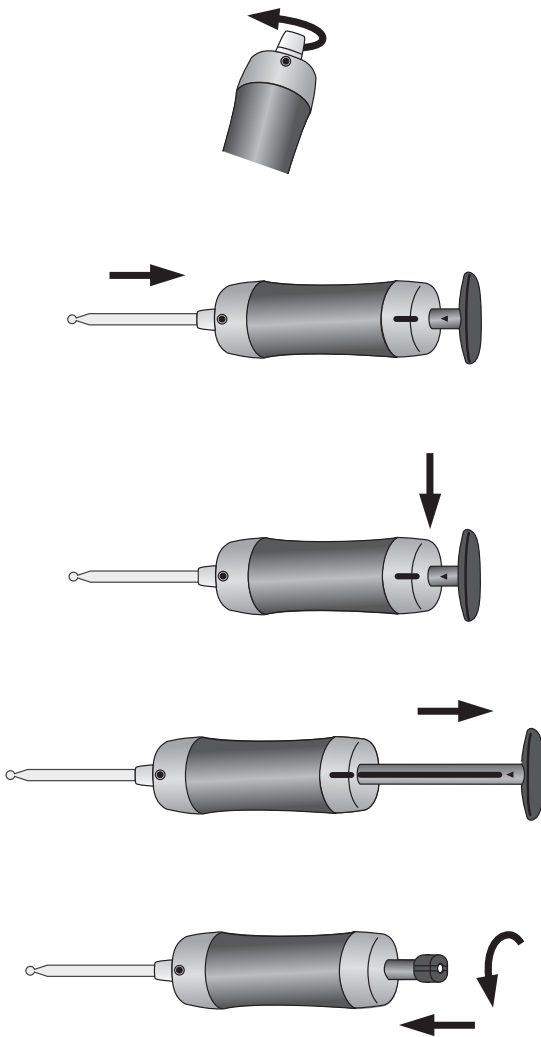

(1) Confirm that the inlet clamping nut is firmly tightened.

(2) After confirming that the pump handle is fully in (therefore, the guide line on the pump shaft is not seen), insert a fresh unbroken detector tube into the rubber inlet of the pump.

(3) Align the guide mark (red line) on the back plate and the guide mark (▲100) on the handle.

(4) Pull out the handle fully along the red guide line on the pump shaft to the lock position, and wait 1 minute.

(5) Unlock the handle by turning it more than 1/4 turns and guide it back gradually.

(6) Confirm the handle returns to the initial position and the guide line on the pump shaft is not seen.

△ NOTE

When the handle is unlocked, be sure to guide it back gradually by applying a little resistance. Otherwise, the handle will spring back due to the vacuum in the pump cylinder and possibly damage internal parts.

Detector Tube

■ Single tube (Example: No. 1HH Carbon Monoxide)

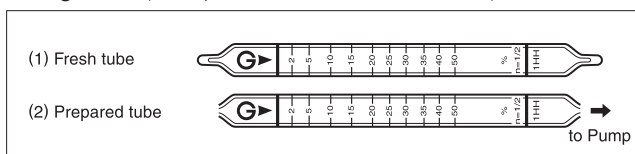

■ Twin tube (Example: No. 163L Ethylene Oxide)

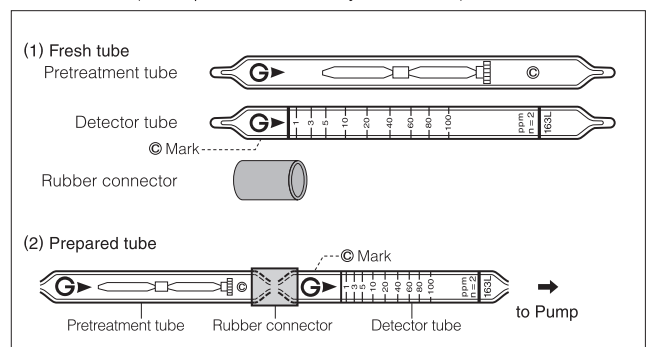

OPERATION

Simple and accurate measurements with the Gastec standard detector tube system

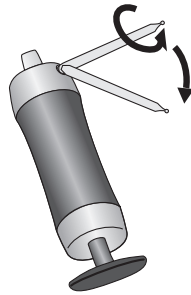

- a) Insert the detector tube end straight into the tube tip breaker of the Pump.
- b) Rotate the detector tube so that the diamond cutter of the tube tip breaker scratches the surface of the tube end.
- c) Hold the detector tube firmly near the tube tip breaker and bend the tube toward you to break the tube tip.

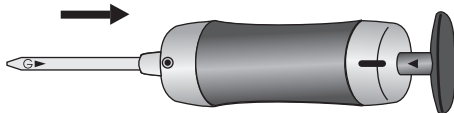

- d) Confirm the pump handle is fully pushed in (therefore, the guide line on the pump shaft is not seen). Then insert the detector tube into the rubber inlet of the Pump with the arrow (▶) on the tube pointing toward the pump.

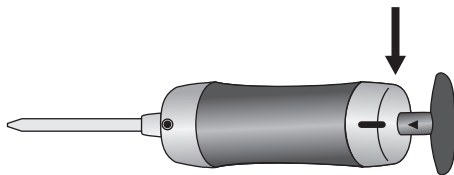

- e) Align the guide mark (red line) on the back plate and the guide mark (▲100 or ▲50 depending on the detector tube) on the handle.

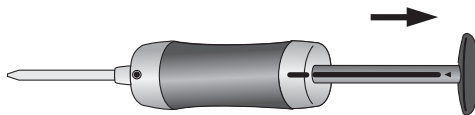

- f) Direct the tube end to the point of measurement and pull out the handle fully (for 100mL sampling) or halfway (for 50mL sampling) along the guide line to the lock position.

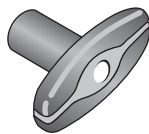

- g) Wait until the sampling time has elapsed. The completion of the sampling of 100mL or 50mL can be confirmed by the following two options.
 - i) Use the built in flow finish indicator
 - ii) Use handle play function
 For details, see the instruction manual provided with the pump.

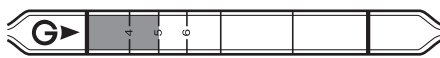

How to read the detector tube

- (a) The end of the colour change layer is flat: Read the value at the end of the layer. In this example, the reading should be 5%.

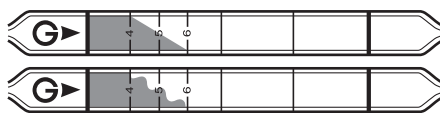

- (b) The end of the colour change layer is slanted: Read the value in the middle of the slant. In this exaggerated example, the reading should be 5%.

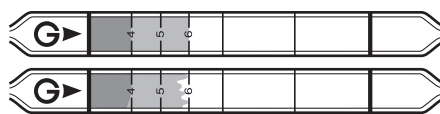

- (c) The demarcation of the colour change layer is pale: Read the value in the middle between the dark layer end and the pale layer end. In this exaggerated example, the reading should be 5%.

△ NOTE

Read instructions for your Gastec detector tube and model GV-100S/110S carefully.

Gas or Vapour to be Measured Chemical Formula	Tube No. & Name		Measuring Range (ppm)	No. of Pump Strokes	Colour Change		Shelf Life (month)	Note	TLV-TWA, C (ACGIH) (ppm)
					Original	Stain			
Acetaldehyde CH ₃ CHO	92	Acetaldehyde	300-750	1	Yellow	Red	36*		C 25
			10-300	②					
	5-10	4							
	92M	Acetaldehyde	5-100	①	Yellow	Red	24*		
	92L	Acetaldehyde	2.5-5	2					
			1-20	1	Yellow	Reddish brown	24*	T	
Acetic acid CH ₃ CO ₂ H	81	Acetic acid	50-100	1/2	Pink	Yellow	36	H	10
			2-50	①					
			1-2	2					
	81L	Acetic acid	10-23.0	1/2	Pink	Pale yellow	24*	T	
0.25-10			①						
0.125-0.25			2						
Acetic anhydride (CH ₃ CO) ₂ O	81	Acetic acid	0.6-15	1	Pink	Yellow	36	H	1
	81L	Acetic acid	0.15-6	1	Pink	Pale yellow	24*	T	
Acetone CH ₃ COCH ₃	151	Acetone	0.8-2.0%	1	Yellowish brown	Greenish brown	36	T	250
			0.05-0.8%	②					
	151L	Acetone	4000-12000	1	Yellow	Red	24*	T	
			50-4000	②					
Acetone cyanohydrin (CH ₃) ₂ C(OH)(CN)	12L	Hydrogen cyanide	2.5-60	1	Yellow	Pink	24	T	C5mg/m ³
Acetonitrile CH ₃ CN	52	Nitro compounds (Pyrotec tube)	3-180	1	White	Yellowish orange	36	P	20
Acetylene HC≡CH	171	Acetylene	2.0-4.0%	1/2	White	Brown	36	T	
			0.1-2.0%	①					
			0.05-0.1%	2					
	103	Hydrocarbons (Lower class)	1.8-3.6%	1/2	Yellowish brown	Greenish brown	30	++	
0.15-1.8%	1								
0.075-0.15%	2								
	172	Ethylene	32.5-1040	1	Pale yellow	Blue	36	T	
Acetylene dichloride	See 1,2-Dichloroethylene								
Acid gases	80	Acid gases	40-80	1	Pale bluish purple	Yellow	24		
			2-40	②					
			1-2	4					
Acrolein CH ₂ :CHCHO	93	Acrolein	10-800	②	Yellow	Red	24*	T	C 0.1
			3.3-10	4					
Acrylic acid CH ₂ :CHCO ₂ H	81	Acetic acid	2-50	1	Pink	Yellow	36	H	2
	81L	Acetic acid	0.45-18	1	Pink	Pale yellow	24*	T	
Acrylonitrile CH ₂ :CHCN	191	Acrylonitrile	120-360	1	Yellow	Red	36	+T	2
			5-120	②					
			2-5	4					
	191L	Acrylonitrile	6-18	1	Yellow	Pink	36	+	
0.2-6	②								
		0.1-0.2	4						
	102L	Hexane	600-14400	1	Yellowish brown	Greenish brown	36		
Aliphatic hydrocarbons	140	Aliphatic hydrocarbons	1000-3000	1/2	Yellow	Blackish brown	24	T	
			20-1000	①					
			6-20	2					
Allyl amine CH ₂ :CHCH ₂ NH ₂	180	Amines	8.5-170	1	Pink	Yellow	36	T	
	180L	Amines	0.4-8	1	Pink	Pale yellowish orange	36	T	

T: Temp Correction H: Humidity Correction +: Twin Tubes ++: Nine Tubes * Refrigerated Storage Mesh: Correction Factor/Chart

P: Use Pyrotec pyrolyzer No. 840 and GASTEC gas sampling pump.

See page 44 for additional symbols and definitions.

Gas or Vapour to be Measured Chemical Formula	Tube No. & Name		Measuring Range (ppm)	No. of Pump Strokes	Colour Change		Shelf Life (month)	Note	TLV-TWA, C (ACGIH) (ppm)
					Original	Stain			
Allyl isothiocyanate CH ₂ :CHCH ₂ NCS	149	Methyl methacrylate	4.4-88	2	Yellow	Pale blue	24	T	
Allyl chloride CH ₂ :CHCH ₂ Cl	101L	Gasoline (Petrol)	0.1-3.4%	1/2	Yellowish brown	Greenish brown	36		1
	131L	Vinyl chloride	3.2-48	2	Yellow	Reddish brown	30*	+T	
Amines CH ₃ NH ₂ calibration	180	Amines	5-100	1	Pink	Yellow to Brown	36	T	
	180L	Amines	0.5-10	1	Pink	Yellow to Pale yellowish orange or Grayish purple	36	T	
2-Aminoethanol	See Ethanolamine								
Ammonia NH ₃	3H	Ammonia	16-32% 1-16% 0.2-1%	1/2 ① 2-5	Purple	Yellow	36		25
	3HM	Ammonia	1.6-3.52% 0.05-1.6%	1/2 ①	Pink	Greenish gray	36		
	3M	Ammonia	500-1000 50-500 10-50	1/2 ① 2-5	Purple	Yellow	36		
	3La	Ammonia	100-220 5-100 2.5-5	1/2 ① 2	Purple	Yellow	36	T	
	3L	Ammonia	30-78 1-30 0.5-1	1/2 ① 2	Pink	Yellow	36	T	
	180	Amines	1.5-30	1	Pink	Yellow	36	T	
Amyl acetate CH ₃ CO ₂ (CH ₂) ₄ CH ₃	147	Amyl acetate	10-200	2	Yellow	Pale blue	24	T	50
Aniline C ₆ H ₅ NH ₂	181	Aniline	30-60 2.5-30 1.25-2.5	2 ③ 5	Pale yellow	Pale green	36		2
Aromatic hydrocarbons	120	Aromatic hydrocarbons	100-200 2-100 0.4-2	1/2 ① 2-5	White	Brown	36		
Arsine AsH ₃	19LA	Arsine	2.4-10 1.5-2.4 0.1-1.5 0.04-0.1	1 3 ⑤ 10	Yellow	Red	27		0.005
Benzaldehyde C ₆ H ₅ CHO	91L	Formaldehyde	4-92	1	Yellow	Reddish brown	36*	T	
Benzene C ₆ H ₆	121S	Benzene	120-312 5-120 2-5	1 ② 4	White	Dark green	36	+	0.5
	121	Benzene	60-120 5-60 2.5-5	1 ② 4	White	Dark green	36		
	121SL	Benzene	20-100 1-20	1 ⑤	White	Dark green	36	+	
	121SP	Benzene	20-66 0.2-20	1 ③	White	Brown	24	+M	
	121L	Benzene	10-65 0.1-10	1 ⑤	White	Dark green	36	+	
	171	Acetylene	0.03-0.6%	4	White	Brown	36	T	
Benzyl bromide C ₆ H ₅ CH ₂ Br	136L	Methyl bromide	11-100	1	White	Yellow	27	+	

T: Temp Correction H: Humidity Correction +: Twin Tubes ++: Nine Tubes * Refrigerated Storage Mesh: Correction Factor/Chart
P: Use Pyrotec pyrolyzer No. 840 and GASTEC gas sampling pump.
See page 44 for additional symbols and definitions.

Gas or Vapour to be Measured Chemical Formula	Tube No. & Name		Measuring Range (ppm)	No. of Pump Strokes	Colour Change		Shelf Life (month)	Note	TLV-TWA, C (ACGIH) (ppm)
					Original	Stain			
Benzyl chloride C ₆ H ₅ CH ₂ Cl	132L	Trichloroethylene	1.6-20	2	Yellow	Purple	30*	T	1
Boron trichloride BCl ₃	12L	Hydrogen cyanide	2.25-54	1	Yellow	Pink	24	T	C 0.7
Bromine Br ₂	8La	Chlorine	0.05-0.8	4	White	Pale pink	36		0.1
Bromochloromethane	See Chlorobromomethane								
Bromoform CHBr ₃	136L	Methyl bromide	1-50	1	White	Yellow	27	+	0.5
1,3-Butadiene CH ₂ :CHCH:CH ₂	174	1,3-Butadiene	50-800	1	Pale yellow	White	36	T	2
	174L	1,3-Butadiene	5-100 2.5-5	④ 8	Pale yellow	White	36		
	174LL	1,3-Butadiene	0.5-5	1	Pink	Pale yellow	36*	+	
Butane C ₄ H ₁₀	104	Butane	25-1400	1	Yellowish brown	Greenish brown	36		STEL 1000 ^(EX)
	103	Hydrocarbons (Lower class)	0.84-1.68%	1/2	Yellowish brown	Greenish brown	30	++	
			0.07-0.84%	1					
0.035-0.07%	2								
1-Butanol CH ₃ CH ₂ CH ₂ CH ₂ OH	114	1-Butanol	10-150	3	Yellow	Pale blue	36	T	20
2-Butanol CH ₃ CH ₂ CH(OH)CH ₃	115	2-Butanol	5-150	3	Yellow	Pale blue	36	T	100
2-Butanone	See Methyl ethyl ketone (MEK)								
Butyl acetate CH ₃ CO ₂ (CH ₂) ₃ CH ₃	142	Butyl acetate	0.05-0.8%	2	Orange	Greenish brown	36	T	50
	142L	Butyl acetate	10-300	2	Yellow	Blackish brown (Pale blue after few minutes)	24	T	
tert-Butyl alcohol (CH ₃) ₃ COH	102L	Hexane	500-12000	2	Yellowish brown	Greenish brown	36		100
Butyl acrylate CH ₂ :CHCO ₂ C ₄ H ₉	142L	Butyl acetate	7-210	2	Yellow	Blackish brown (Pale blue after few minutes)	24	T	2
Butylamine CH ₃ (CH ₂) ₃ NH ₂	180	Amines	8-160	1	Pink	Grayish red to Brown	36	T	C 5
	180L	Amines	0.55-11	1	Pink	Pale yellowish orange	36	T	
tert-Butylamine (CH ₃) ₃ CNH ₂	180	Amines	5.5-110	1	Pink	Pale brown	36	T	
n-Butyl bromide C ₄ H ₉ Br	136H	Methyl bromide	24-360	1	White	Yellow	36	+	
	136L	Methyl bromide	10-100	1	White	Yellow	27	+	
	136LA	Methyl bromide	2.4-43.2	1	White	Yellow	36	+	
1-18			2						
Butyl mercaptan CH ₃ (CH ₂) ₃ SH	70L	Mercaptans	6.4-12.8	1/2	Yellow	Red	24		0.5
			0.8-6.4	1					
			0.32-0.8	2					
			0.16-0.32	4					
tert-Butyl mercaptan (CH ₃) ₃ CSH	75	tert-Butyl mercaptan	60-150mg/m ³	1/2	Yellow	Red	36	T	
			30-60mg/m ³	1					
			2.5-30mg/m ³	②					
	75N	tert-Butyl mercaptan	50-250mg/m ³	1/2	Yellow	Pink	24	TH	
			2.5-50mg/m ³	①					
			1.25-2.5mg/m ³	2					
75L	tert-Butyl mercaptan	15-30mg/m ³	1/2	Yellow	Pink	24*	T		
		1-15mg/m ³	①						
		0.5-1mg/m ³	2						

T: Temp Correction H: Humidity Correction +: Twin Tubes ++: Nine Tubes * Refrigerated Storage Mesh: Correction Factor/Chart

P: Use Pyrotec pyrolyzer No. 840 and GASTEC gas sampling pump.

See page 44 for additional symbols and definitions.

Gas or Vapour to be Measured Chemical Formula	Tube No. & Name		Measuring Range (ppm)	No. of Pump Strokes	Colour Change		Shelf Life (month)	Note	TLV-TWA, C (ACGIH) (ppm)
					Original	Stain			
tert-Butyl mercaptan (CH ₃) ₃ CSH	75LN	tert-Butyl mercaptan	15-39mg/m ³ 1-15mg/m ³ 0.5-1mg/m ³	1/2 ① 2	Yellow	Pink	24 *	TH	
	77	TBM and DMS	1-15mg/m ³	1	Yellow	Pink	24 *	+T	
	70L	Mercaptans	4-8 0.5-4 0.2-0.5 0.1-0.2	1/2 1 2 4	Yellow	Red	24		
	70LN	Mercaptans	1-40	1	Yellow	Pink	24 *		
Butyric acid CH ₃ CH ₂ CH ₂ CO ₂ H	81L	Acetic acid	0.325-13	1	Pink	Pale yellow	24 *	T	
Butyronitrile CH ₃ CH ₂ CH ₂ CN	191L	Acrylonitrile	6-180	1	Yellow	Pink	36	+	
Carbon dioxide CO ₂	2HH	Carbon dioxide	5-40% 2.5-5%	①② 1	Orange	Yellow	36		5000
	2H	Carbon dioxide	10-20% 1-10% 0.5-1%	1/2 ① 2	White	Purple	36		
	2L	Carbon dioxide	3-6% 0.25-3% 0.13-0.25%	1/2 ① 2	White	Purple	36		
	2LL	Carbon dioxide	300-5000	1	Pale blue	Purple	36		
	2LC	Carbon dioxide	2000-4000 100-2000	1/2 ①	Pale vermilion	Orange	24		
Carbon disulphide CS ₂	13M	Carbon disulphide	1600-5120 50-1600 15-50	1/2 ① 2	Purple	Yellow	36	+T	1
	13	Carbon disulphide	50-100 2.5-50 1.25-2.5 0.63-1.25	1/2 ① 2 4	Blue	Yellow	36	+T	
	13L	Carbon disulphide	3.0-8.1 0.1-3.0	1 ②	Bluish purple	White	36	+T	
Carbon monoxide CO	1HH	Carbon monoxide	2-50% 1-2%	①② 1	White	Blackish brown	36		25
	1H	Carbon monoxide	5-10% 0.2-5% 0.1-0.2%	1/2 ① 2	White	Blackish brown	36		
	1M	Carbon monoxide	2-4% 0.1-2% 0.05-0.1%	1/2 ① 2	White	Pale brown	36		
	1LM	Carbon monoxide (in Hydrogen)	1000-2000 50-1000 25-50	1/2 ① 2	White	Pale brown/Pale green (dual layers)	36		
	1L	Carbon monoxide	1000-2000 25-1000 2.5-25	1/2 ① 2-10	Yellow	Blackish brown	36		
	1La	Carbon monoxide	500-1000 25-500 12.5-25 8-12.5	1/2 ① 2 3	Yellow	Blackish brown	36	T	

T: Temp Correction H: Humidity Correction +: Twin Tubes ++: Nine Tubes * Refrigerated Storage Mesh: Correction Factor/Chart
P: Use Pyrotec pyrolyzer No. 840 and GASTEC gas sampling pump.
See page 44 for additional symbols and definitions.

Gas or Vapour to be Measured Chemical Formula	Tube No. & Name		Measuring Range (ppm)	No. of Pump Strokes	Colour Change		Shelf Life (month)	Note	TLV-TWA, C (ACGIH) (ppm)						
					Original	Stain									
Carbon monoxide CO	1LK	Carbon monoxide (in Hydrogen)	300-600	1/2	White	Pale brown/Pale green (dual layers)	36		25						
			100-300	1											
			5-100	③											
	1LK	Carbon monoxide (in Hydrogen with Hydrocarbons)	5-100	3	White	Pale brown/Pale green (dual layers)	36	+							
	1LL	Carbon monoxide	5-50	2	Yellow	Blackish brown	36								
	1LC	Carbon monoxide	1-30	1	White	Pale pink	24	T							
Carbon tetrachloride CCl ₄	134	Carbon tetrachloride	2.5-60	①	White	Yellow	12*	+	5						
			0.5-2.5	2-5											
	134L	Carbon tetrachloride	5-11 0.25-5	1 ②	White	Yellow	12*	+							
Carbonyl chloride	See Phosgene														
Carbonyl sulphide COS	21	Carbonyl sulphide	100-200	1/2	Blue	Yellow	30*	+	5						
			10-100	①											
			5-10	2											
	21LA	Carbonyl sulphide	50-125 5-50 2-5	1/2 ① 2	Bluish purple	White	36*	+T							
Chlorine Cl ₂	8HH	Chlorine	0.5-10%	①/②	Reddish purple	Yellow	36		0.1						
			0.25-0.5%	1											
	8H	Chlorine	500-1000	1/2	White	Reddish orange	36								
			50-500	①											
			25-50	2											
	8La	Chlorine	8-16	1/2	White	Pale pink	36								
0.5-8			①												
0.1-0.5			2-5												
8LL	Chlorine	1-2	1/2	White	Pale green	12*									
		0.05-1	①												
		0.025-0.05	2												
80	Acid gases	0.7-14	2	Pale bluish purple	White	24									
Chlorine dioxide ClO ₂	23M	Chlorine dioxide	5-10	1/2	White	Pale pink	36		C 0.1						
			0.5-5	①											
			0.1-0.5	2-5											
	23L	Chlorine dioxide	0.6-1.2	1/2	White	Pale green	12*								
			0.05-0.6	①											
		0.025-0.05	2												
8H	Chlorine	45-450	1	White	Reddish orange	36									
8La	Chlorine	0.3-4.8	1	White	Pale pink	36									
Chlorobenzene C ₆ H ₅ Cl	126	Chlorobenzene	200-500	1/2	White	Grayish brown	36		10						
			5-200	①											
			2-5	2											
	126L	Chlorobenzene	10-57 0.5-10	1 ③	Yellow	Pale bluish purple	24*	T							
Chlorobromomethane CH ₂ BrCl	135	1,1,1-Trichloroethane (Methyl chloroform)	22-110	1	White	Reddish orange	36	+T	200						
			136H	Methyl bromide						18-270	1	White	Yellow	36	+
			136L	Methyl bromide						11-110	1	White	Yellow	27	+
			136LA	Methyl bromide						0.7-12.6	2	White	Yellow	36	+

T: Temp Correction H: Humidity Correction +: Twin Tubes ++: Nine Tubes * Refrigerated Storage Mesh: Correction Factor/Chart

P: Use Pyrotec pyrolyzer No. 840 and GASTEC gas sampling pump.

See page 44 for additional symbols and definitions.

Gas or Vapour to be Measured Chemical Formula	Tube No. & Name		Measuring Range (ppm)	No. of Pump Strokes	Colour Change		Shelf Life (month)	Note	TLV-TWA, C (ACGIH) (ppm)
					Original	Stain			
Chlorocyclohexane C ₆ H ₁₁ Cl	102L	Hexane	50-1200	2	Yellowish brown	Greenish brown	36		
Chlorodifluoromethane (R22) CHClF ₂	51H	Fluorochlorocarbons (Pyrotec tube)	0.8-2.4% 0.1-0.8%	1/2 1	White	Reddish orange	36	+P	1000
	51	Fluorochlorocarbons (Pyrotec tube)	25-1000	1	Yellow	Reddish purple	36	+P	
	51L	Fluorochlorocarbons (Pyrotec tube)	50-135 2.5-50	1 2	Yellow	Reddish purple	36	+P	
1-Chloro-2,3-epoxy propane	See Epichlorohydrin								
2-Chloroethanol	See Ethylene chlorohydrin								
Chloroethylene	See Vinyl chloride								
Chloroform CHCl ₃	137	Chloroform	100-400	3	White	Orange	36	+H	10
			10-100	⑤					
			4-10	7					
137LA	Chloroform	12-30	1	White	Pale purple	12 *	+T		
		2-12	②						
		0.5-2	4						
137LL	Chloroform	0.3-4.5	4	White	Pale purple	12 *	+T		
Chloropicrin Cl ₃ CNO ₂	233	Chloropicrin	10-22	1/2	White	Yellow	12	+	0.1
			0.1-10	①					
			0.045-0.1	2					
134	Carbon tetrachloride	2.5-60	1	White	Yellow	12 *	+		
134L	Carbon tetrachloride	0.28-5.5	2	White	Yellow	12 *	+		
2-Chloro-1,1,1,2-tetrafluoroethane(R124) CHClFClF ₃	51	Fluorochlorocarbons (Pyrotec tube)	45-1800	1	Yellow	Reddish purple	36	+P	
m-Cresol C ₆ H ₄ (CH ₃)OH	61	o-Cresol	1-25	2	Pale yellow	Gray	24 *	T	20mg/m ³ (FV)
o-Cresol C ₆ H ₄ (CH ₃)OH	61	o-Cresol	25-67.5	1	Pale yellow	Gray	24 *	T	20mg/m ³ (FV)
			1-25	②					
			0.35-1	4					
p-Cresol C ₆ H ₄ (CH ₃)OH	61	o-Cresol	1-25	2	Pale yellow	Gray	24 *	T	20mg/m ³ (FV)
Cumene C ₆ H ₅ CH(CH ₃) ₂	122L	Toluene	2-100	2	White	Brown	36		5
Cyclohexane C ₆ H ₁₂	102H	Hexane	0.6-1.2%	1/2	Yellowish brown	Greenish brown	36		100
			0.03-0.6%	1					
			0.015-0.03%	2					
102L	Hexane	60-1440	1	Yellowish brown	Greenish brown	36			
Cyclohexanol C ₆ H ₁₁ OH	118	Cyclohexanol	5-100	2	Yellow	Pale blue	24	T	50
Cyclohexanone C ₆ H ₁₀ O	154	Cyclohexanone	30-72	2	Pale yellow	Yellow	24 *	T	20
			2-30	④					
91L	Formaldehyde	10-470	1/2	Yellow	Reddish brown	36 *	T		
Cyclohexene C ₆ H ₁₀	151	Acetone	0.05-0.8%	1	Yellowish brown	Greenish brown	36	T	20
Cyclohexylamine C ₆ H ₁₃ N	180	Amines	7-140	1	Pink	Pale yellowish orange	36	T	10
			0.5-10	1					

T: Temp Correction H: Humidity Correction +: Twin Tubes ++: Nine Tubes * Refrigerated Storage Mesh: Correction Factor/Chart
P: Use Pyrotec pyrolyzer No. 840 and GASTEC gas sampling pump.
See page 44 for additional symbols and definitions.

Gas or Vapour to be Measured Chemical Formula	Tube No. & Name		Measuring Range (ppm)	No. of Pump Strokes	Colour Change		Shelf Life (month)	Note	TLV-TWA, C (ACGIH) (ppm)
					Original	Stain			
Cymene C ₁₀ H ₁₄	141L	Ethyl acetate	2.4-96	2	Yellow	Blackish brown	24	T	
n-Decane CH ₃ (CH ₂) ₈ CH ₃	105	Hydrocarbons (Higher class)	400-6000 200-400	1 2	White	Blackish brown	36		
Diacetone alcohol (CH ₃) ₂ C(OH)CH ₂ COCH ₃	154	Cyclohexanone	2-100	2	Pale yellow	Yellow	24*	T	50
Diacetyl CH ₃ COCOCH ₃	92	Acetaldehyde	25-1500	3	Yellow	Red	36*		0.01
1,2-Diaminoethane	See Ethylenediamine								
Diborane B ₂ H ₆	22	Diborane	2-5 0.05-2 0.02-0.05	1 ② 5	Yellow	Red	24	T	0.1
1,1-Dibromoethane CH ₃ CHBr ₂	136L	Methyl bromide	7-70	1	White	Yellow	27	+	
1,2-Dibromoethane	See Ethylene dibromide								
Dibromomethane CH ₂ Br ₂	136L	Methyl bromide	5-50	1	White	Yellow	27	+	
Di-n-butylamine (CH ₃ CH ₂ CH ₂ CH ₂) ₂ NH	180	Amines	5-100	1	Pink	Pale orange	36	T	
	180L	Amines	0.4-8	1	Pink	Pale yellowish orange	36	T	
m-Dichlorobenzene C ₆ H ₄ Cl ₂	127	o-Dichlorobenzene	2.5-300	2	White	Light brown	36	T	
o-Dichlorobenzene C ₆ H ₄ Cl ₂	127	o-Dichlorobenzene	2.5-300	2	White	Light brown	36	T	25
p-Dichlorobenzene C ₆ H ₄ Cl ₂	127	o-Dichlorobenzene	2.5-300	2	White	Light brown	36	T	10
Dichlorodifluoromethane (R12) CCl ₂ F ₂	51H	Fluorochlorocarbons (Pyrotec tube)	2600-7800 325-2600	1/2 1	White	Reddish orange	36	+P	1000
	51	Fluorochlorocarbons (Pyrotec tube)	11-440	1	Yellow	Reddish purple	36	+P	
	51L	Fluorochlorocarbons (Pyrotec tube)	36-97.2 1.8-36	1 2	Yellow	Reddish purple	36	+P	
1,1-Dichloroethane CH ₃ CHCl ₂	135	1,1,1-Trichloroethane (Methyl chloroform)	90-450	1	White	Reddish orange	36	+T	100
1,2-Dichloroethane	See Ethylene dichloride								
1,1-Dichloroethylene	See Vinylidene chloride								
1,2-Dichloroethylene ClCH:CHCl	139	1,2-Dichloroethylene	100-250 10-100 5-10	1/2 ① 2	Yellow	Reddish purple	30*	T	200
	132HA	Trichloroethylene	80-800	1	Yellow	Reddish purple	24*	T	
	132LL	Trichloroethylene	0.375-6.0	1	Yellow	Purple	24*	T	
1,1-Dichloro-1-fluoroethane (R141b) CH ₃ CCl ₂ F	51	Fluorochlorocarbons (Pyrotec tube)	400-1000 10-400	1/2 1	Yellow	Reddish purple	36	+P	
	51L	Fluorochlorocarbons (Pyrotec tube)	1.1-22	2	Yellow	Reddish purple	36	+P	
Dichloromethane	See Methylene chloride								
Dichloropentafluoropropane (R225)	51	Fluorochlorocarbons (Pyrotec tube)	20-800	1	Yellow	Reddish purple	36	+P	
	51L	Fluorochlorocarbons (Pyrotec tube)	1.4-28	2	Yellow	Reddish purple	36	+P	

T: Temp Correction H: Humidity Correction +: Twin Tubes ++: Nine Tubes * Refrigerated Storage Mesh: Correction Factor/Chart

P: Use Pyrotec pyrolyzer No. 840 and GASTEC gas sampling pump.

See page 44 for additional symbols and definitions.

Gas or Vapour to be Measured Chemical Formula	Tube No. & Name		Measuring Range (ppm)	No. of Pump Strokes	Colour Change		Shelf Life (month)	Note	TLV-TWA, C (ACGIH) (ppm)
					Original	Stain			
1,2-Dichloropropane	See Propylene dichloride								
1,3-Dichloropropene ClCH ₂ CH:CHCl	132HA	Trichloroethylene	45-450	2	Yellow	Reddish purple	24*	T	1
	131La	Vinyl chloride	0.5-10	2	Yellow	Reddish brown	24*	+	
1,2-Dichloro-1,1,2,2-tetrafluoroethane (R114) CClF ₂ CClF ₂	51H	Fluorochlorocarbons (Pyrotec tube)	3800-11400 475-3800	1/2 1	White	Reddish orange	36	+P	1000
	51	Fluorochlorocarbons (Pyrotec tube)	20-800	1	Yellow	Reddish purple	36	+P	
	51L	Fluorochlorocarbons (Pyrotec tube)	36-97.2 1.8-36	1 2	Yellow	Reddish purple	36	+P	
2,2-Dichloro-1,1,1-trifluoroethane (R123) CHCl ₂ CF ₃	51	Fluorochlorocarbons (Pyrotec tube)	560-1600 14-560	1/2 1	Yellow	Reddish purple	36	+P	
	51L	Fluorochlorocarbons (Pyrotec tube)	1.4-28	2	Yellow	Reddish purple	36	+P	
Dichlorvos C ₄ H ₇ Cl ₂ O ₄ P	132LL	Trichloroethylene	0.11-1.8	2	Yellow	Purple	24*	T	0.1mg/m ³ (FV)
Diethylamine (C ₂ H ₅) ₂ NH	180	Amines	5.5-110	1	Pink	Pale brown	36	T	5
	180L	Amines	0.45-9	1	Pink	Pale yellowish orange	36	T	
Diethylaminoethanol (C ₂ H ₅)NCH ₂ CH ₂ OH	180L	Amines	0.6-12	1	Pink	Pale yellowish orange	36	T	2
Diethyl benzene C ₆ H ₄ (C ₂ H ₅) ₂	122L	Toluene	2-150	4	White	Brown	36		
Diethylenetriamine H ₂ NCH ₂ CH ₂ NHCH ₂ CH ₂ NH ₂	180L	Amines	0.95-19	1	Pink	Grayish purple (Pale yellowish orange at the end of staining)*1	36	T	1
Diethylethanolamine (C ₂ H ₅) ₂ NC ₂ H ₄ OH	180	Amines	6-120	1	Pink	Pale brown	36	T	2
Diethyl ether	See Ethyl ether								
Diethyl ketone C ₅ H ₁₀ O	142L	Butyl acetate	5-513	2	Yellow	Blackish brown (Pale blue after few minutes)	24	T	200
Diisobutylene (CH ₃) ₃ CCH:C(CH ₃) ₂	121	Benzene	45-540	1	White	Dark green	36		
Diisobutyl ketone	102L	Hexane	0.2-1%	2	Yellowish brown	Greenish brown	36		25
	91L	Formaldehyde	0.58-29	4	Yellow	Reddish brown	36*	T	
Diisopropylamine [(CH ₃) ₂ CH] ₂ NH	180	Amines	5-100	1	Pink	Pale orange	36	T	5
	180L	Amines	0.3-6	1	Pink	Pale yellowish orange	36	T	
Diisopropyl benzene C ₆ H ₅ N [CH(CH ₃) ₂] ₂	141L	Ethyl acetate	16-108	2	Yellow	Blackish brown	24	T	
1,2-Dimethoxyethane C ₄ H ₁₀ O ₂	114	1-Butanol	100-1030	1	Yellow	Pale blue	36	T	
N,N-Dimethyl acetamide CH ₃ CON(CH ₃) ₂	184	N,N-Dimethyl acetamide	60-240 5-60 1.5-5	1 ② 4	Pink	Pale yellow	36	T	10
Dimethylamine (CH ₃) ₂ NH	3H	Ammonia	1.2-19.2%	1	Purple	Yellow	36		5
	180	Amines	5.5-110	1	Pink	Pale yellowish orange	36	T	
	180L	Amines	0.45-9	1	Pink	Pale yellowish orange	36	T	
2-Dimethylaminoethanol (CH ₃) ₂ NCH ₂ CH ₂ OH	180	Amines	6.5-130	1	Pink	Pale orange to Yellow	36	T	
	180L	Amines	0.65-13	1	Pink	Pale yellowish orange	36	T	
Dimethylaminopropylamine (CH ₃) ₂ NCH ₂ CH ₂ CH ₂ NH ₂	180	Amines	8-160	1	Pink	Grayish red	36	T	
	180L	Amines	0.6-12	1	Pink	Pale yellowish orange	36	T	
N,N-Dimethylaniline C ₆ H ₅ N(CH ₃) ₂	181	Aniline	2.5-30	3	Pale yellow	Pale green	36		5
Dimethylbenzene	See Xylene								

T: Temp Correction H: Humidity Correction +: Twin Tubes ++: Nine Tubes * Refrigerated Storage Mesh: Correction Factor/Chart
P: Use Pyrotec pyrolyzer No. 840 and GASTEC gas sampling pump. *1: Pale yellowish orange when low concentration
See page 44 for additional symbols and definitions.

Gas or Vapour to be Measured Chemical Formula	Tube No. & Name		Measuring Range (ppm)	No. of Pump Strokes	Colour Change		Shelf Life (month)	Note	TLV-TWA, C (ACGIH) (ppm)
					Original	Stain			
Dimethyl disulphide (CH ₃) ₂ S ₂	53	Dimethyl sulphide (Pyrotec tube)	0.3-6	3	Bluish purple	White	24	+TP	0.5
Dimethylethanolamine	See 2-Dimethylaminoethanol								
N,N-Dimethylethylamine C ₂ H ₅ N(CH ₃) ₂	180	Amines	4-80	1	Pink	Yellow	36	T	
	180L	Amines	0.3-6	1	Pink	Pale yellowish orange	36	T	
N,N-Dimethyl formamide HCON(CH ₃) ₂	183	N,N-Dimethyl formamide	30-90	1/2	Pink	Pale vermilion	36	T	5
			2-30	①					
			0.8-2	2					
2,6-Dimethyl-4-heptanone	See Diisobutyl ketone								
Dimethylhydrazine NH ₂ N(CH ₃) ₂	185	Hydrazine	0.1-2	5	Pink	Yellow	36	TH	0.01
Dimethyl sulphide (CH ₃) ₂ S	53	Dimethyl sulphide (Pyrotec tube)	0.5-10 0.15-0.5	③ 5	Bluish purple	White	24	+TP	10
	77	TBM and DMS	1-15mg/m ³	1	Pink	Pale yellow	24*	+	
1,4-Dioxane C ₄ H ₈ O ₂	159	Tetrahydrofuran	25-144	2	Pale vermilion	Pale blue	36	T	20
	163	Ethylene oxide	0.1-6.0%	1	Orange	Green	36		
Dipropylamine (CH ₃ CH ₂ CH ₂) ₂ NH	180	Amines	4-80	1	Pink	Yellow	36	T	
	180L	Amines	0.35-7	1	Pink	Pale yellowish orange	36	T	
Divinyl benzene C ₆ H ₄ (CH:CH ₂) ₂	124L	Styrene	1-15	3	White	Yellow	36		10
Divinyl methoxysilane (CH ₂ :CH ₂) ₂ CH ₃ OSi	113L	Isopropyl alcohol	6.5-25.0	2	Pale vermilion	Pale blue	36	T	
Enflurane (2-Chloro-1,1,2-trifluoroethyl difluoromethyl ether) CHClFCH ₂ OCHF ₂	51	Fluorochlorocarbons (Pyrotec tube)	110-1230	1	Yellow	Reddish purple	36	+P	75
	51L	Fluorochlorocarbons (Pyrotec tube)	25-145	2	Yellow	Reddish purple	36	+P	
Epichlorohydrin CH ₂ OCHCH ₂ Cl	163L	Ethylene oxide	1.2-120	2	Yellow	Reddish brown	12*	+T	0.5
1,2-Epoxypropane	See Propylene oxide								
Ethanthiol	See Ethyl mercaptan								
Ethanol C ₂ H ₅ OH	112	Ethanol	2.5-7.5%	1/2	Pale vermilion	Pale blue	36	T	STEL 1000
			0.05-2.5%	①					
			0.01-0.05%	2					
112L	Ethanol	100-2000 50-100	① 2	Pale vermilion	Pale blue	36	T		
Ethyl alcohol	See Ethanol								
Ethanolamine (Monoethanolamine) H ₂ NCH ₂ CH ₂ OH	180	Amines	7-140	3	Pink	Yellow	36	T	3
	180L	Amines	1.95-39	1	Pink	Grayish purple (Pale yellowish orange at the end of staining)**1	36	T	
Ethyl acetate CH ₃ CO ₂ C ₂ H ₅	141	Ethyl acetate	0.1-1.5%	1	Yellowish brown	Greenish brown	36	T	400
	141L	Ethyl acetate	20-800	2	Yellow	Blackish brown	24	T	
Ethyl acrylate CH ₂ :CHCO ₂ C ₂ H ₅	141L	Ethyl acetate	8.4-336	2	Yellow	Blackish brown	24	T	5
Ethylamine C ₂ H ₅ NH ₂	180	Amines	5-100	1	Pink	Yellow	36	T	5
	180L	Amines	0.45-9	1	Pink	Pale yellowish orange	36	T	
Ethyl benzene C ₆ H ₅ C ₂ H ₅	122	Toluene	11-330	1	White	Brown	36		20
	122L	Toluene	1-70	2	White	Brown	36		
p-Ethyl benzylchloride C ₆ H ₄ (C ₂ H ₅)CH ₂ Cl	131La	Vinyl chloride	2.5-50	2	Yellow	Reddish brown	24*	+	

T: Temp Correction H: Humidity Correction +: Twin Tubes ++: Nine Tubes * Refrigerated Storage Mesh: Correction Factor/Chart

P: Use Pyrotec pyrolyzer No. 840 and GASTEC gas sampling pump. **1: Pale yellowish orange when low concentration

See page 44 for additional symbols and definitions.

Gas or Vapour to be Measured Chemical Formula	Tube No. & Name		Measuring Range (ppm)	No. of Pump Strokes	Colour Change		Shelf Life (month)	Note	TLV-TWA, C (ACGIH) (ppm)
					Original	Stain			
Ethyl bromide C ₂ H ₅ Br	136L	Methyl bromide	100-200 10-100 2.5-10	1/2 1 4	White	Yellow	27	+	5
Ethyl chloroformate ClCO ₂ C ₂ H ₅	131La	Vinyl chloride	7-140	2	Yellow	Reddish brown	24 *	+	
Ethyl chloride C ₂ H ₅ Cl	138	Methylene chloride	15-150	1	White	Pale pink	36	+T	100
Ethylene CH ₂ :CH ₂	172	Ethylene	800-1680 25-800	1/2 ①	Pale yellow	Blue	36	T	200
	172L	Ethylene	50-100 0.2-50	2 ④	Pale yellow	Blue	36	T	
	103	Hydrocarbons (Lower class)	8.4-16.8% 0.7-8.4% 0.35-0.7%	1/2 1 2	Yellowish brown	Greenish brown	30	++	
	171	Acetylene	0.1-2.0%	1	White	Brown	36	T	
Ethylene chlorohydrin ClCH ₂ CH ₂ OH	111L	Methanol	80-200	3	Pale vermilion	Pale blue	36	T	C 1
Ethylenediamine H ₂ NCH ₂ CH ₂ NH ₂	180	Amines	14-280	1	Pink	Yellow	36	T	10
	180L	Amines	0.9-18	1	Pink	Pale yellowish orange	36	T	
Ethylene dibromide BrCH ₂ CH ₂ Br	136H	Methyl bromide	14-210	1	White	Yellow	36	+	
	136L	Methyl bromide	8-80	1	White	Yellow	27	+	
Ethylene dichloride ClCH ₂ CH ₂ Cl	232	1,2-Dichloroethane	15-39 1-15	1 ②	White	Pale purple	12 *	+T	10
	135	1,1,1-Trichloroethane (Methyl chloroform)	400-2000	1	White	Reddish orange	36	+T	
	135L	1,1,1-Trichloroethane (Methyl chloroform)	104-1040	1	White	Pale pink	27	+T	
Ethylene glycol HOCH ₂ CH ₂ OH	165L	Ethylene glycol	10-100mg/m ³	2	Yellow	Reddish brown	36 *	+T	25(V)
Ethylene glycol monobutyl ether CH ₃ (CH ₂) ₃ OCH ₂ CH ₂ OH	113L	Isopropyl alcohol	200-1000	2	Pale vermilion	Pale blue	36	T	20
	113LL	Isopropyl alcohol	60-400	2	Pale vermilion	Pale blue	24	T	
Ethylene glycol monoethyl ether C ₂ H ₅ OCH ₂ CH ₂ OH	113L	Isopropyl alcohol	110-1000	2	Pale vermilion	Pale blue	36	T	5
	113LL	Isopropyl alcohol	46-460	2	Pale vermilion	Pale blue	24	T	
Ethylene glycol monomethyl ether CH ₃ OCH ₂ CH ₂ OH	113L	Isopropyl alcohol	75-760	2	Pale vermilion	Pale blue	36	T	0.1
	113LL	Isopropyl alcohol	44-440	2	Pale vermilion	Pale blue	24	T	
Ethylene glycol monomethyl ether acetate	See 2-Methoxyethyl acetate								
Ethylene oxide C ₂ H ₄ O	163	Ethylene oxide	0.05-3.0%	1	Orange	Green	36		1
	163L	Ethylene oxide	100-550 1-100 0.4-1	1 ② 4	Yellow	Reddish brown	12 *	+T	
			163LL	Ethylene oxide					
Ethyl ether (C ₂ H ₅) ₂ O	161	Ethyl ether	0.04-1.0%	1	Yellowish brown	Greenish brown	36	T	400
	161L	Ethyl ether	400-1120 10-400	1 ②	Yellow	Pale blue	24	T	
Ethylidene chloride	See 1,1-Dichloroethane								

T: Temp Correction H: Humidity Correction +: Twin Tubes ++: Nine Tubes * Refrigerated Storage Mesh: Correction Factor/Chart
P: Use Pyrotec pyrolyzer No. 840 and GASTEC gas sampling pump.
See page 44 for additional symbols and definitions.

Gas or Vapour to be Measured Chemical Formula	Tube No. & Name		Measuring Range (ppm)	No. of Pump Strokes	Colour Change		Shelf Life (month)	Note	TLV-TWA, C (ACGIH) (ppm)
					Original	Stain			
Ethyl mercaptan C ₂ H ₅ SH	72	Ethyl mercaptan	5-120	①	White	Yellow	36	T	0.5
			0.5-5	2-10					
	72L	Ethyl mercaptan	30-75	1/2	Yellow	Red	24	T	
			0.5-30	①					
			0.2-0.5	2					
	72LN	Ethyl mercaptan	25-57.5	1/2	Yellow	Pink	24	T	
			0.5-25	①					
0.15-0.5	2								
70	Mercaptans	5-120	1	White	Yellow	36	T		
0.5-5	2-10								
70L	Mercaptans	4-8	1/2	Yellow	Red	24			
		0.5-4	1						
		0.2-0.5	2						
		0.1-0.2	4						
70LN	Mercaptans	4.4-10.4	1/2	Yellow	Pink	24*			
		0.55-4.4	1						
		0.25-0.55	2						
		0.13-0.25	4						
71H	Methyl mercaptan	100-3800	1	White	Yellow	36			
N-Ethyl morpholine C ₆ H ₁₃ NO	180	Amines	5-100	1	Pink	Yellow	36	T	5
	180L	Amines	0.3-6	1	Pink	Pale yellowish orange	36	T	
Fluorine F ₂	17	Hydrogen fluoride	0.5-50	1	Yellow	Brown	36	H	0.1
Fluorotrichloromethane	See Trichlorofluoromethane (R11)								
Formaldehyde HCHO	91M	Formaldehyde	2000-6400	1/2	Yellow	Red	24*	T	0.1
			20-2000	①					
			8-20	2					
	91	Formaldehyde	50-100	1/2	White	Brown	36	+	
20-50	1								
2-20	②								
91L	Formaldehyde	5.0-45.0	1	Yellow	Reddish brown	36*	T		
0.1-5.0	⑤								
91LL	Formaldehyde	0.05-1	5	Yellowish brown	Pale pink	12*	T		
Formic acid HCO ₂ H	81	Acetic acid	5.2-130	1	Pink	Yellow	36	H	5
	81L	Acetic acid	0.5-20	1	Pink	Pale yellow	24*	T	
Furfural C ₅ H ₄ O ₂	154	Cyclohexanone	2-30	4	Pale yellow	Yellow	24*	T	0.2
Gasoline (Petrol) C _n H _m	101	Gasoline (Petrol)	0.6-1.2%	1/2	Yellowish brown	Greenish brown	36		300
			0.03-0.6%	①					
			0.015-0.03%	2					
101L	Gasoline (Petrol)	1000-2000	1	Yellowish brown	Greenish brown	36			
30-1000	②								
1M	Carbon monoxide	0.1-2%	1	White	Pale brown	36			
Halothane (2-Bromo-2-chloro-1,1,1-trifluoroethane) CF ₃ CHBrCl	51H	Fluorochlorocarbons (Pyrotec tube)	800-6400	1	White	Reddish orange	36	+P	50
	51	Fluorochlorocarbons (Pyrotec tube)	24-960	1	Yellow	Reddish purple	36	+P	
	51L	Fluorochlorocarbons (Pyrotec tube)	3-60	2	Yellow	Reddish purple	36	+P	

T: Temp Correction H: Humidity Correction +: Twin Tubes ++: Nine Tubes * Refrigerated Storage Mesh: Correction Factor/Chart

P: Use Pyrotec pyrolyzer No. 840 and GASTEC gas sampling pump.

See page 44 for additional symbols and definitions.

Gas or Vapour to be Measured Chemical Formula	Tube No. & Name		Measuring Range (ppm)	No. of Pump Strokes	Colour Change		Shelf Life (month)	Note	TLV-TWA, C (ACGIH) (ppm)
					Original	Stain			
Heptane CH ₃ (CH ₂) ₅ CH ₃	101	Gasoline (Petrol)	0.6-1.2%	1/2	Yellowish brown	Greenish brown	36		400
			0.03-0.6%	1					
			0.015-0.03%	2					
	101L	Gasoline (Petrol)	1000-2000 30-1000	1 2	Yellowish brown	Greenish brown	36		
103	Hydrocarbons (Lower class)	0.84-1.68%	1/2	Yellowish brown	Greenish brown	30	++		
		0.07-0.84%	1						
		0.035-0.07%	2						
105	Hydrocarbons (Higher class)	180-2700	1	White	Blackish brown	36			
		90-180	2						
Hexamethylenediamine H ₂ N(CH ₂) ₆ NH ₂	180L	Amines	1.55-31	1	Pink	Grayish purple (Pale yellowish orange at the end of staining)*1	36	T	0.5
Hexane CH ₃ (CH ₂) ₄ CH ₃	102H	Hexane	0.6-1.2%	1/2	Yellowish brown	Greenish brown	36		50
			0.03-0.6%	①					
			0.015-0.03%	2					
	102L	Hexane	50-1200	①	Yellowish brown	Greenish brown	36		
			25-50	2					
9-25	4								
3.5-9	8								
103	Hydrocarbons (Lower class)	0.6-1.2%	1/2	Yellowish brown	Greenish brown	30	++		
		0.05-0.6%	1						
		0.025-0.05%	2						
105	Hydrocarbons (Higher class)	160-2400	1	White	Blackish brown	36			
		80-160	2						
Hexone	See Methyl isobutyl ketone								
2-Hexyl alcohol CH ₃ (CH ₂) ₅ CH(OH)CH ₃	141L	Ethyl acetate	168-1680	2	Yellow	Blackish brown	24	T	
Hexylamine CH ₃ (CH ₂) ₅ NH ₂	180	Amines	9-180	1	Pink	Pale orange	36	T	
	180L	Amines	0.65-13	1	Pink	Pale yellowish orange	36	T	
Hydrazine N ₂ H ₄	185	Hydrazine	0.1-2 0.04-0.1	⑤ 10	Pink	Yellow	36	TH	0.01
Hydrocarbons (Higher Class)	105	Hydrocarbons (Higher class)	200-3000	①	White	Blackish brown	36		
			100-200	2					
Hydrocarbons (Lower Class)	103	Hydrocarbons (Lower class)	1.2-2.4%	1/2	Yellowish brown	Greenish brown	30	++	
			0.1-1.2%	①					
			0.05-0.1%	2					
Hydrogen H ₂	30	Hydrogen	0.5-2%	1	Yellow	Yellowish brown	36		
Hydrogen bromide HBr	15L	Nitric acid	0.8-16	1	Yellow	Reddish purple	36	H	C 2
Hydrogen chloride HCl	14R	Hydrogen chloride (for Low Humidity)	200-5000	①	Purple	*2 Yellow/Pale pink	36		C 2
			50-200	2-4					
	14M	Hydrogen chloride	500-1000	1/2	Yellow	Red	36		
			20-500	①					
	10-20	2							
14L	Hydrogen chloride	20-76	1/2	Yellow	Pink	36			
		1-20	①						
0.2-1	2-5								
8HH	Chlorine	1.5-30%	1/2	Reddish purple	Yellow	36			
80	Acid gases	8-160	2	Pale bluish purple	Pale reddish purple	24			

T: Temp Correction H: Humidity Correction +: Twin Tubes ++: Nine Tubes * Refrigerated Storage Mesh: Correction Factor/Chart
 *1: Pale yellowish orange when low concentration *2: Become "Yellow" under about 500 ppm. Become "Pale pink" over about 500 ppm.
 P: Use Pyrotec pyrolyzer No. 840 and GASTEC gas sampling pump.
 See page 44 for additional symbols and definitions.

Gas or Vapour to be Measured Chemical Formula	Tube No. & Name		Measuring Range (ppm)	No. of Pump Strokes	Colour Change		Shelf Life (month)	Note	TLV-TWA, C (ACGIH) (ppm)
					Original	Stain			
Hydrogen cyanide HCN	12H	Hydrogen cyanide	0.05-1.6%	1	Yellow	White	36	T	C 4.7
	12M	Hydrogen cyanide	800-2400	1/2	Yellow	Red	36		
			50-800	①					
			17-50	2					
12L	Hydrogen cyanide	60-150	1/2	Yellow	Pink	24	T		
		2.5-60	①						
		1.25-2.5	2						
		0.5-1.25	5						
12LL	Hydrogen cyanide	5-10 0.2-5	1 ②	Yellow	Pink	24			
Hydrogen fluoride HF	17	Hydrogen fluoride	20-100	1	Yellow	※3 Brown / Deep pink	36	H	0.5
			0.5-20 0.25-0.5	④ 7					
	17L	Hydrogen fluoride	10-72 0.2-10 0.09-0.2	1 ③ 5	Yellow	Brown	30	H	
17LL	Hydrogen fluoride	6.9-24	1	Yellow	Brown	24	TH		
		3.0-6.9	3						
		0.05-3.0	⑤						
Hydrogen peroxide H ₂ O ₂	32	Hydrogen peroxide	0.5-10	5	White	Yellow	36	T	1
Hydrogen sulphide H ₂ S	4HT	Hydrogen sulphide	20-40%	1/2	Pale blue	Blackish brown	36		
			2-20%	①					
			1-2%	2					
	4HP	Hydrogen sulphide	10-20%	1/2	Pale blue	Blackish brown	36		
			0.5-10%	①					
			0.25-0.5%	2					
	4HH	Hydrogen sulphide	2-4%	1/2	Pale blue	Blackish brown	36		
			0.1-2%	①					
	4H	Hydrogen sulphide	2000-4000	1/2	White	Brown	36		
			100-2000	①					
			10-100	2-10					
	4HM	Hydrogen sulphide	800-1600	1/2	White	Brown	36		
			50-800	①					
25-50			2						
4M	Hydrogen sulphide	250-500	1/2	White	Brown	36			
		25-250	①						
		12.5-25	2						
4L	Hydrogen sulphide	120-240	1/2	White	Brown	36			
		10-120	①						
		1-10	2-10						
4LL	Hydrogen sulphide	60-120	1/2	White	Brown	36			
		2.5-60	①						
		0.25-2.5	2-10						
4LK	Hydrogen sulphide	20-40	1/2	White	Brown	36			
		2-20	①						
		1-2	2						
4LB	Hydrogen sulphide	6-12	1/2	Yellow	Pink	24			
		1-6	①						
		0.5-1	2						
4LT	Hydrogen sulphide	2.0-4.0	1/2	Yellow	Pink	24*			
		0.1-2.0	①						
		0.05-0.1	2						
45S	Hydrogen sulphide, Sulphur dioxide (Separate quantification)	H ₂ S: 60-120	1/2	White	Brown	36	+		
		2.5-60 1.25-2.5	① 2						

T: Temp Correction H: Humidity Correction +: Twin Tubes ++: Nine Tubes * Refrigerated Storage Mesh: Correction Factor/Chart

※3 May become "Deep pink" at high concentration.

P: Use Pyrotec pyrolyzer No. 840 and GASTEC gas sampling pump.

See page 44 for additional symbols and definitions.

Gas or Vapour to be Measured Chemical Formula	Tube No. & Name		Measuring Range (ppm)	No. of Pump Strokes	Colour Change		Shelf Life (month)	Note	TLV-TWA, C (ACGIH) (ppm)
					Original	Stain			
Hydrogen sulphide + Sulphur dioxide (Total Quantification) H ₂ S+SO ₂	45H	Hydrogen sulphide + Sulphur dioxide	4.0-8.0%	1/2	Brown	Pale yellow	36		
			0.2-4.0%	①					
			0.02-0.2%	2-10					
4-Hydroxy-4-methyl-2-pentanone	See Diacetone alcohol								
Iodine I ₂	9L	Nitrogen dioxide	0.2-12	2	White	Yellowish orange	36		0.01 ^(IFV)
	80	Acid gases	0.12-2.4	2	Pale bluish purple	Light bluish gray	24		
Isoamyl acetate CH ₃ CO ₂ (CH ₂) ₂ CH(CH ₃) ₂	148	Isoamyl acetate	10-200	2	Yellow	Pale blue	24	T	50
Isoamyl alcohol (CH ₃) ₂ CH(CH ₂) ₂ OH	117	Isoamyl alcohol	5-300	2	Yellow	Pale blue	36	T	100
Isobutane (CH ₃) ₃ CH	103	Hydrocarbons (Lower class)	0.84-1.68%	1/2	Yellowish brown	Greenish brown	30	++	STEL 1000 ^(EX)
			0.07-0.84%	1					
			0.035-0.07%	2					
	104	Butane	55-3080	1	Yellowish brown	Greenish brown	36		
Isobutene (CH ₃) ₂ C:CH ₂	101L	Gasoline (Petrol)	0.07-2.2%	1	Yellowish brown	Greenish brown	36		250
Isobutyl acetate CH ₃ CO ₂ CH ₂ CH(CH ₃) ₂	144	Isobutyl acetate	10-300	2	Yellow	Blackish brown	24	T	50
Isobutyl acrylate CH ₂ :CHCO ₂ CH ₂ CH(CH ₃) ₂	142L	Butyl acetate	5.5-165	2	Yellow	Blackish brown (Pale blue after few minutes)	24	T	
Isobutyl alcohol (CH ₃) ₂ CHCH ₂ OH	116	Isobutyl alcohol	10-150	②	Yellow	Pale blue	36	T	50
			3.7-10	4					
Isooctane (CH ₃) ₃ CCH ₂ CH(CH ₃) ₂	101	Gasoline (Petrol)	0.027-0.54%	1	Yellowish brown	Greenish brown	36		300
Isopentane (CH ₃) ₂ CHCH ₂ CH ₃	103	Hydrocarbons (Lower class)	1.08-2.16%	1/2	Yellowish brown	Greenish brown	30	++	1000
			0.09-1.08%	1					
			0.045-0.09%	2					
Isopentyl acetate	See Isoamyl acetate								
Isopentyl alcohol	See Isoamyl alcohol								
Isophorone C ₉ H ₁₄ O	154	Cyclohexanone	2-30	8	Pale yellow	Yellow	24 *	T	C 5
Isopropyl acetate CH ₃ CO ₂ CH(CH ₃) ₂	146	Isopropyl acetate	10-500	2	Yellow	Blackish brown	24	T	100
Isopropyl alcohol CH ₃ CH(OH)CH ₃ (i-C ₃ H ₇ OH)	113	Isopropyl alcohol	2.5-5.0%	1/2	Pale vermilion	Pale blue	36	T	200
			0.04-2.5%	①					
				0.02-0.04%	2				
	113L	Isopropyl alcohol	50-800	①	Pale vermilion	Pale blue	36	T	
			20-50	2					
	113LL	Isopropyl alcohol	200-460	1	Pale vermilion	Pale blue	24	T	
			20-200	②					
Isopropyl amine (CH ₃) ₂ CHNH ₂	180	Amines	5.5-110	1	Pink	Pale yellowish orange	36	T	2
	180L	Amines	0.45-9	1	Pink	Pale yellowish orange	36	T	
Isopropyl ether [(CH ₃) ₂ (CH)] ₂ O	141L	Ethyl acetate	17.6-704	2	Yellow	Blackish brown	24	T	250
	161	Ethyl ether	0.018-0.45%	2	Yellowish brown	Greenish brown	36	T	
Isopropyl mercaptan (CH ₃) ₂ CHSH	70	Mercaptans	10-240	1	White	Yellow	36	T	
Isovaleric acid (CH ₃) ₂ CHCH ₂ CO ₂ H	81	Acetic acid	2-50	1	Pink	Yellow	36	H	
	81L	Acetic acid	0.38-15	1	Pink	Pale yellow	24 *	T	

T: Temp Correction H: Humidity Correction +: Twin Tubes ++: Nine Tubes * Refrigerated Storage Mesh: Correction Factor/Chart
P: Use Pyrotec pyrolyzer No. 840 and GASTEC gas sampling pump.
See page 44 for additional symbols and definitions.

Gas or Vapour to be Measured Chemical Formula	Tube No. & Name		Measuring Range (ppm)	No. of Pump Strokes	Colour Change		Shelf Life (month)	Note	TLV-TWA, C (ACGIH) (ppm)
					Original	Stain			
LPG (Liquified petroleum gas)	100A	LPG	0.02-0.8%	1	Yellowish brown	Greenish brown	36		
Maleic anhydride C ₄ H ₂ O ₃	81	Acetic acid	0.8-20	1	Pink	Yellow	36	H	0.01mg/m ³ (FV)
Mercaptans R · SH	70	Mercaptans	5-120	①	White	Yellow	36	T	
			0.5-5	2-10					
	70L	Mercaptans	4-8	1/2	Yellow	Red	24		
			0.5-4	①					
70LN	Mercaptans	0.2-0.5	2	Yellow	Pink	24*			
		0.1-0.2	4						
2-Mercaptoethanol HSCH ₂ CH ₂ OH	75L	tert-Butyl mercaptan	0.5-7.5	1	Yellow	Pink	24*	T	
Mercury vapour Hg	40	Mercury vapour	6-13.2mg/m ³ 0.25-6mg/m ³ 0.05-0.25mg/m ³	1/2 ① 5	White	Pale orange	36		0.025mg/m ³
Mesityl oxide (CH ₃) ₂ C:CHCOCH ₃	141L	Ethyl acetate	72-1080	2	Yellow	Blackish brown	24	T	15
Methacrylic acid CH ₂ :C(CH ₃)COOH	81	Acetic acid	1.8-45	1	Pink	Yellow	36	H	20
	81L	Acetic acid	0.35-14	1	Pink	Pale yellow	24*	T	
Methacrylonitrile CH ₂ :C(CH ₃)CN	192	Methacrylonitrile	10-32 0.5-10 0.2-0.5	1 ② 4	Yellow	Red	36	+	1
Metaldehyde (CH ₃ CHO) _n	91L	Formaldehyde	0.065-3.25	3	Yellow	Reddish brown	36*	T	
Methanethiol	See Methyl mercaptan								
Methanol CH ₃ OH	111	Methanol	1.5-6.0%	1/2	Pale vermilion	Pale blue	36	T	200
			0.02-1.5%	①					
			0.007-0.02%	2					
			0.002-0.007%	4					
111L	Methanol	40-1000	①	Pale vermilion	Pale blue	36	T		
		20-40	2						
111LL	Methanol	20-62	2	Pale yellow	Pale bluish green	24	T		
		2-20	④						
2-Methoxyethyl acetate CH ₃ CO ₂ CH ₂ CH ₂ OCH ₃	113L	Isopropyl alcohol	300-1300	2	Pale vermilion	Pale blue	36	T	0.1
1-Methoxy-2-propanol CH ₃ OCH ₂ CH(OH)CH ₃	113LL	Isopropyl alcohol	26-260	2	Pale vermilion	Pale blue	24	T	50
Methyl alcohol	See Methanol								
Methyl acrylate CH ₂ :CHCO ₂ CH ₃	141L	Ethyl acetate	7.2-288	2	Yellow	Blackish brown	24	T	2
2-Methyl allyl chloride CH ₂ :C(CH ₃)CH ₂ Cl	131La	Vinyl chloride	2.8-55	1	Yellow	Reddish brown	24*	+	
Methylamine CH ₃ NH ₂	180	Amines	5-100	1	Pink	Pale brown to Yellow	36	T	5
	180L	Amines	0.5-10	1	Pink	Pale yellowish orange	36	T	

T: Temp Correction H: Humidity Correction +: Twin Tubes ++: Nine Tubes * Refrigerated Storage Mesh: Correction Factor/Chart

P: Use Pyrotec pyrolyzer No. 840 and GASTEC gas sampling pump.

See page 44 for additional symbols and definitions.

Gas or Vapour to be Measured Chemical Formula	Tube No. & Name		Measuring Range (ppm)	No. of Pump Strokes	Colour Change		Shelf Life (month)	Note	TLV-TWA, C (ACGIH) (ppm)
					Original	Stain			
N-Methyl aniline C ₆ H ₅ NHCH ₃	181	Aniline	3.5-42	2	Pale yellow	Pale green	36		0.5
Methyl bromide CH ₃ Br	136H	Methyl bromide	300-600	1/2	White	Yellow	36	+	1
			20-300	①					
	10-20	2							
	136L	Methyl bromide	100-200	1/2	White	Yellow	27	+	
			10-100	①					
			2.5-10	4					
	136LA	Methyl bromide	18-36	1	White	Yellow	36	+	
			1-18	②					
	136LL	Methyl bromide	1.2-3.0	1	White	Pale purple	24	+T	
			0.1-1.2	②					
2-Methyl-3-butenitrile CH ₂ :CHCH(CH ₃)CN	191L	Acrylonitrile	0.4-12	2	Yellow	Pink	36	+	
Methyl tert-butyl ether CH ₃ OC(CH ₃) ₃	166	Methyl tert-butyl ether	200-660	1	Yellow	Pale blue	24	T	50
			10-200	②					
Methyl chloride CH ₃ Cl	51	Fluorochlorocarbons (Pyrotec tube)	12-480	1	Yellow	Reddish purple	36	+P	50
	51L	Fluorochlorocarbons (Pyrotec tube)	32-86.4	1	Yellow	Reddish purple	36	+P	
			1.6-32	2					
Methyl chloroform	See 1,1,1-Trichloroethane								
Methyl chloroformate ClCO ₂ CH ₃	131La	Vinyl chloride	58-1160	5	Yellow	Reddish brown	24 *	+	
Methylcyclohexane C ₆ H ₁₁ CH ₃	102H	Hexane	0.04-0.84%	1	Yellowish brown	Greenish brown	36		400
Methylcyclohexanol CH ₃ C ₆ H ₁₀ OH	119	Methylcyclohexanol	5-100	2	Yellow	Pale blue	24	T	50
Methylcyclohexanone C ₇ H ₁₂ O	155	Methylcyclohexanone	50-80	2	Pale yellow	Yellow	24 *	T	20
			2-50	③					
Methylene chloride CH ₂ Cl ₂	138	Methylene chloride	50-500	①	White	Pale pink	36	+T	50
			30-50	2					
	138L	Methylene chloride	60-150	1	White	Pale pink	24	+T	
			10-60	②					
			4-10	4					
	51L	Fluorochlorocarbons (Pyrotec tube)	20-54	1	Yellow	Reddish purple	36	+P	
			1-20	2					
Methylene iodide CH ₂ I ₂	121L	Benzene	0.22-22	5	White	Dark green	36	+	
Methyl ether CH ₃ OCH ₃	161	Ethyl ether	0.034-0.85%	1	Yellowish brown	Greenish brown	36	T	
Methyl ethyl ketone CH ₃ COC ₂ H ₅	152	Methyl ethyl ketone	0.02-0.6%	2	Yellowish brown	Greenish brown	36	T	200
	152L	Methyl ethyl ketone	120-384	1/2	Yellow	Reddish purple	24 *	+T	
			10-120	①					
	151L	Acetone	21-1680	5	Yellow	Red	24 *	T	
Methyl hydrazine H ₂ NNHCH ₃	185	Hydrazine	0.6-12	5	Pink	Yellow	36	TH	0.01

T: Temp Correction H: Humidity Correction +: Twin Tubes ++: Nine Tubes * Refrigerated Storage Mesh: Correction Factor/Chart
P: Use Pyrotec pyrolyzer No. 840 and GASTEC gas sampling pump.
See page 44 for additional symbols and definitions.

Gas or Vapour to be Measured Chemical Formula	Tube No. & Name		Measuring Range (ppm)	No. of Pump Strokes	Colour Change		Shelf Life (month)	Note	TLV-TWA, C (ACGIH) (ppm)
					Original	Stain			
Methyl iodide CH ₃ I	230H	Methyl iodide	15000-34800	1/2	White	Dark brown	24	T	2
			6000-15000	1					
			100-6000	②					
	230	Methyl iodide	46-108	1/2	White	Gray	24*	T	
20-46	1								
1-20	②								
0.5-1	4								
121L	Benzene	0.32-32	5	White	Dark green	36	+		
Methyl isobutyl ketone (CH ₃) ₂ CHCH ₂ COCH ₃	153	Methyl isobutyl ketone	0.05-0.6%	2	Orange	Greenish brown	36	T	20
	153L	Methyl isobutyl ketone	50-130 2.5-50	1/2 ①	Pale yellow	Pale blue	12	T	
Methyl isothiocyanate CH ₃ NCS	166	Methyl tert-butyl ether	88.3-1766 39.8-796	1/2 1	Yellow	Pale blue	24	T	
	141L	Ethyl acetate	5.4-216	2	Yellow	Blackish brown	24	T	
	234L	Methyl isothiocyanate	10-25 0.3-10 0.07-0.3	1/2 ① 2	Pink	Yellow	24	+T	
Methyl mercaptan CH ₃ SH	71H	Methyl mercaptan	1000-2700	1/2	White	Yellow	36		0.5
			50-1000	①					
			20-50	2					
	71	Methyl mercaptan	70-140	1/2	White	Yellow	36	T	
	2.5-70		①						
	0.25-2.5	2-10							
70	Mercaptans	3.5-84	1	White	Yellow	36	T		
0.35-3.5		2-10							
70L	Mercaptans	4-8	1/2	Yellow	Red	24			
0.5-4		1							
0.2-0.5		2							
0.1-0.2		4							
70LN	Mercaptans	4-8	1/2	Yellow	Pink	24*			
0.5-4		1							
0.2-0.5		2							
0.1-0.2		4							
Methyl methacrylate CH ₂ :C(CH ₃)CO ₂ CH ₃	149	Methyl methacrylate	200-500 10-200	1 ②	Yellow	Pale blue	24	T	50
N-Methyl morpholine CH ₃ N(C ₂ H ₄) ₂ O	180	Amines	5-100	1	Pink	Yellow	36	T	
	180L	Amines	0.3-6	1	Pink	Pale yellowish orange	36	T	
4-Methyl pyridine C ₆ H ₇ N	182	Pyridine	0.38-10.5	1	Pink	Yellow	36	T	
N-Methyl pyrrolidone C ₅ H ₉ NO	180	Amines	13.5-270	1	Pink	White	36	T	
Monochlorobenzene	See Chlorobenzene								
Morpholine NH(C ₂ H ₄)O	180	Amines	9-180	1	Pink	Yellow	36	T	20
	180L	Amines	0.5-10	1	Pink	Pale yellowish orange	36	T	
Naphthalene C ₁₀ H ₈	60	Phenol	0.5-14	2	Pale yellow	Gray	24*	T	10

T: Temp Correction H: Humidity Correction +: Twin Tubes ++: Nine Tubes * Refrigerated Storage Mesh: Correction Factor/Chart

P: Use Pyrotec pyrolyzer No. 840 and GASTEC gas sampling pump.

See page 44 for additional symbols and definitions.

Gas or Vapour to be Measured Chemical Formula	Tube No. & Name		Measuring Range (ppm)	No. of Pump Strokes	Colour Change		Shelf Life (month)	Note	TLV-TWA, C (ACGIH) (ppm)
					Original	Stain			
Nitric acid HNO ₃	15L	Nitric acid	20-40	1/2	Yellow	Reddish purple	36	H	2
			1-20	①					
	80	Acid gases	5-100	2	Pale bluish purple	Pale reddish purple	24		
Nitroethane CH ₃ CH ₂ NO ₂	52	Nitro compounds (Pyrotec tube)	4-240	1	White	Yellowish orange	36	P	100
Nitrogen dioxide NO ₂	9L	Nitrogen dioxide	30-125	1	White	Yellowish orange	36		0.2
			0.5-30	②					
	10	Nitrogen oxides (NO & NO ₂) (Separate quantification)	2.5-200	1	White	Yellowish orange	36	+	
	80	Acid gases	0.2-4	2	Pale bluish purple	Pinkish gray	24		
	52	Nitrogen compounds (Pyrotec tube)	0.5-30	1	White	Yellowish orange	36	P	
Nitrogen oxide NO	10	Nitrogen oxides (NO & NO ₂) (Separate quantification)	5-200	①	White	Yellowish orange	36	+T	25
			2.5-5	2					
Nitrogen oxides NO+NO ₂	11HA	Nitrogen oxides (NO+NO ₂) (Total quantification)	50-2500	1	White	Green	24		NO : 25 NO ₂ : 0.2
	11S	Nitrogen oxides (NO+NO ₂) (Total quantification)	250-625	1/2	White	Pale green	24		
			10-250	①					
	11L	Nitrogen oxides (NO+NO ₂) (Total quantification)	5-10	2					
			5.0-14	1	White	Yellowish orange	36		
			0.2-5.0	②					
			0.06-0.2	4					
			0.03-0.06	8					
Nitromethane CH ₃ NO ₂	52	Nitro compounds (Pyrotec tube)	5-300	1	White	Yellowish orange	36	P	20
1-Nitropropane CH ₃ CH ₂ CH ₂ NO ₂	52	Nitro compounds (Pyrotec tube)	4.2-252	1	White	Yellowish orange	36	P	25
2-Nitropropane (CH ₃) ₂ CHNO ₂	52	Nitro compounds (Pyrotec tube)	3.7-222	1	White	Yellowish orange	36	P	10
Nitrotrichloromethane	See Chloropicrin								
Nonane CH ₃ (CH ₂) ₇ CH ₃	105	Hydrocarbons (Higher class)	260-3900	1	White	Blackish brown	36		200
			130-260	2					
Octane CH ₃ (CH ₂) ₆ CH ₃	101	Gasoline (Petrol)	0.036-0.72%	1	Yellowish brown	Greenish brown	36		300
	105	Hydrocarbons(Higher class)	200-3000	1	White	Blackish brown	36		
			100-200	2					
Oxygen O ₂	31B	Oxygen	6-24%	①②	Black	White	36	⊕	
			3-6%	1					
Ozone O ₃	18M	Ozone	200-400	1/2	Orange	Pale yellow	36		Heavy work:0.05 Moderate work:0.08 Light work:0.10
			20-200	①					
			4-20	2-5					
	18L	Ozone	3-6	1/2	Blue	White	36		Heavy, moderate, or light workloads (≤2hours):0.20
			0.6-3	1					
			0.05-0.6	⑤					
			0.025-0.05	10					
Pentachloroethane Cl ₂ CHCCl ₃	133L	Tetrachloroethylene	40-500	1	Yellow	Pink	30*	T	

T: Temp Correction H: Humidity Correction +: Twin Tubes ++: Nine Tubes * Refrigerated Storage Mesh: Correction Factor/Chart
⊕ Five tests (tubes) and long size glass detector tube for tube 31B only. P: Use Pyrotec pyrolyzer No. 840 and GASTEC gas sampling pump.
See page 44 for additional symbols and definitions.

Gas or Vapour to be Measured Chemical Formula	Tube No. & Name		Measuring Range (ppm)	No. of Pump Strokes	Colour Change		Shelf Life (month)	Note	TLV-TWA, C (ACGIH) (ppm)
					Original	Stain			
1,3-Pentadiene CH ₃ CH:CHCH:CH ₂	174	1,3-Butadiene	250-4000	1	Pale yellow	White	36	T	
	174L	1,3-Butadiene	42.5-850	4	Pale yellow	White	36		
Pentamethylenediamine H ₂ N(CH ₂) ₅ NH ₂	180L	Amines	0.75-15	1	Pink	Grayish purple (Pale yellowish orange at the end of staining)*1	36	T	
n-Pentane CH ₃ (CH ₂) ₃ CH ₃	103	Hydrocarbons (Lower class)	0.9-1.8%	1/2	Yellowish brown	Greenish brown	30	++	1000
			0.075-0.9%	1					
			0.0375-0.075%	2					
	104	Butane	30-1680	1	Yellowish brown	Greenish brown	36		
2-Pentenenitrile CH ₃ CH ₂ CH:CHCN	193	2-Pentenenitrile	6-15 0.5-6	2 ④	Yellow	Red	36	+T	
	191L	Acrylonitrile	0.24-7.2	2	Yellow	Pink	36	+	
3-Pentenenitrile CH ₃ CH:CHCH ₂ CN	191L	Acrylonitrile	0.4-12	2	Yellow	Pink	36	+	
Pentyl acetate	See n-Amyl acetate								
Perchloroethylene	See Tetrachloroethylene								
Petroleum benzine	106	Petroleum naphtha	14-28mg/L	1/2	Yellowish brown	Greenish brown	36		
			1-14mg/L	1					
			0.5-1mg/L	2					
Petroleum distillates	See Gasoline (Petrol)								
Petroleum ether	106	Petroleum naphtha	14-28mg/L	1/2	Yellowish brown	Greenish brown	36		
			1-14mg/L	1					
			0.5-1mg/L	2					
Petroleum naphtha	106	Petroleum naphtha	14-28mg/L	1/2	Yellowish brown	Greenish brown	36		
			1-14mg/L	①					
			0.5-1mg/L	2					
Phenol C ₆ H ₅ OH	60	Phenol	70-183	1/2	Pale yellow	Gray	24*	T	5
			25-70	1					
			1-25	②					
			0.12-1	4					
Phenylethylene	See Styrene								
Phosgene COCl ₂	16	Phosgene	5-20	1	White	Yellow	18*	T	C 0.02
			0.1-5	⑤					
			0.05-0.1	10					
Phosphine PH ₃	7H	Phosphine	2500-5500 200-2500	1/2 ①	Yellow	Blackish brown	36	T	0.05
	7J	Phosphine	500-1000 25-500 2.5-25	1/2 ① 2-10	White	Pale yellow	36		
	7	Phosphine	50-100 5-50 2.5-5	1	White	Pale yellow	36		
				② 4					
	7L	Phosphine	0.3-5 0.15-0.3	⑤ 10	Pale yellow	Purple	36		
	7LA	Phosphine	2.5-9.8 1.5-2.5 0.1-1.5 0.05-0.1	1	Yellow	Red	24		
				3					
				⑤					
				10					

T: Temp Correction H: Humidity Correction +: Twin Tubes ++: Nine Tubes * Refrigerated Storage Mesh: Correction Factor/Chart

P: Use Pyrotec pyrolyzer No. 840 and GASTEC gas sampling pump.

*1: Pale yellowish orange when low concentration

See page 44 for additional symbols and definitions.

Gas or Vapour to be Measured Chemical Formula	Tube No. & Name		Measuring Range (ppm)	No. of Pump Strokes	Colour Change		Shelf Life (month)	Note	TLV-TWA, C (ACGIH) (ppm)
					Original	Stain			
α -Pinene C ₁₀ H ₁₆	121	Benzene	95-1140	3	White	Dark green	36		20
Propane CH ₃ CH ₂ CH ₃	103	Hydrocarbons(Lower class)	1.2-2.4% 0.1-1.2% 0.05-0.1%	1/2 1 2	Yellowish brown	Greenish brown	30	++	
1-Propanethiol	See Propyl mercaptan								
Propionaldehyde CH ₃ CH ₂ CHO	91L 151L	Formaldehyde Acetone	0.76-38 24-1880	1 2	Yellow Yellow	Reddish brown Red	36 * 24 *	T T	20
Propionic acid CH ₃ CH ₂ COOH	81 81L	Acetic acid Acetic acid	3-75 0.25-10	1 1	Pink Pink	Yellow Pale yellow	36 24 *	H T	10
Propionitrile CH ₃ CH ₂ CN	191	Acrylonitrile	50-1200	4	Yellow	Red	36	+T	
Propyl acetate CH ₃ CO ₂ CH ₂ CH ₂ CH ₃	145	Propyl acetate	20-500	2	Yellow	Blackish brown	24	T	100
Propyl alcohol CH ₃ (CH ₂) ₂ OH	113 113L 113LL	Isopropyl alcohol Isopropyl alcohol Isopropyl alcohol	0.04-2.5% 130-560 55-170	1 1 2	Pale vermilion Pale vermilion Pale vermilion	Pale blue Pale blue Pale blue	36 36 24	T T T	100
Propylamine CH ₃ (CH ₂) ₂ NH ₂	180 180L	Amines Amines	6-120 0.5-10	1 1	Pink Pink	Pale yellowish orange Pale yellowish orange	36 36	T T	
n-Propyl bromide CH ₃ (CH ₂) ₂ Br	136LA	Methyl bromide	1-18	2	White	Yellow	36	+	0.1
Propylene CH ₃ CH:CH ₂	100A	LPG	0.02-0.8%	1	Yellowish brown	Greenish brown	36		500
Propylene dichloride CH ₃ CHClCH ₂ Cl	131La	Vinyl chloride	40-800	2	Yellow	Reddish brown	24 *	+	10
Propylene imine CH ₃ CHCH ₂ NH	180 180L	Amines Amines	5.5-110 0.35-7	1 1	Pink Pink	Yellow Pale yellowish orange	36 36	T T	0.2
Propylene oxide CH ₃ CHCH ₂ O	163 163L	Ethylene oxide Ethylene oxide	0.065-3.9% 1-100	1 1	Orange Yellow	Green Reddish brown	36 12 *	 +T	2
Propyl mercaptan CH ₃ (CH ₂) ₂ SH	70 70L 70LN	Mercaptans Mercaptans Mercaptans	22.5-540 4.8-9.6 0.6-4.8 0.24-0.6 0.12-0.24 1-25	1 1/2 1 2 4 1	White Yellow Yellow	Yellow Red Pink	36 24 24 *	T 	
Pyridine C ₅ H ₅ N	182	Pyridine	14-36.4 0.5-14 0.2-0.5	1/2 ① 2	Pink 	Yellow 	36	T	1
Stoddard solvent	128	Stoddard solvent	50-8000mg/m ³	1	White	Brown (ring)	36		100
Styrene C ₆ H ₅ CH:CH ₂	124 124L 153	Styrene Styrene Methyl isobutyl ketone	500-1500 20-500 10-20 25-100 2-25 0.15-2.3%	1/2 ① 2 ④ 2	White White White Orange	Yellow Yellow Yellow Greenish brown	36 36 36	 T	10

T: Temp Correction H: Humidity Correction +: Twin Tubes ++: Nine Tubes * Refrigerated Storage Mesh: Correction Factor/Chart
P: Use Pyrotec pyrolyzer No. 840 and GASTEC gas sampling pump.
See page 44 for additional symbols and definitions.

Gas or Vapour to be Measured Chemical Formula	Tube No. & Name		Measuring Range (ppm)	No. of Pump Strokes	Colour Change		Shelf Life (month)	Note	TLV-TWA, C (ACGIH) (ppm)
					Original	Stain			
Sulphur dioxide SO ₂	5H	Sulphur dioxide	4-8% 0.5-4% 0.05-0.5%	1/2 ① 2-10	Orange	Green	36		STEL 0.25
	5M	Sulphur dioxide	1800-3600 100-1800 20-100	1/2 ① 4	Purple	Yellow	36	T	
	5L	Sulphur dioxide	100-200 5-100 2.5-5 1.25-2.5	1/2 ① 2 4	Blue	Yellow	36		
	5La	Sulphur dioxide	30-60 2-30 1-2 0.5-1	1 ② 4 8	Blue	Yellow	36		
	5LC	Sulphur dioxide	10-22 0.25-10 0.1-0.25	1 ② 4	Bluish purple	White	36	T	
	5Lb	Sulphur dioxide	5-10 0.2-5 0.1-0.2 0.05-0.1	1 ② 4 8	Yellowish green	Yellow	36		
	45S	Hydrogen sulphide, Sulphur dioxide (Separate quantification)	SO ₂ : 10-20 0.5-10 0.25-0.5	1/2 ① 2	Yellowish green	Yellow	36	+	
	80	Acid gases	1.5-30	2	Pale bluish purple	Yellow	24		
Sulphur dioxide +Hydrogen sulphide (Total Quantification) SO ₂ +H ₂ S	45H	Hydrogen sulphide +Sulphur dioxide	4.0-8.0% 0.2-4.0% 0.02-0.2%	1/2 ① 2-10	Brown	Pale yellow	36		
Sulphuric acid H ₂ SO ₄	35	Sulphuric acid	0.5-5mg/m ³	5	Pale yellow	Reddish purple	24	T	0.2mg/m ^{3(T)}
Sulphuryl fluoride	See page 31								
1,1,2,2-Tetrabromoethane Br ₂ CHCHBr ₂	135L	1,1,1-Trichloroethane (Methyl chloroform)	0.92-9.2	4	White	Pale Pink	27	+T	0.1
1,1,2,2-Tetrachloro-1,2-difluoroethane (R112) CCl ₂ FCCL ₂ F	51H	Fluorochlorocarbons (Pyrotec tube)	1000-3000 125-1000	1/2 1	White	Reddish orange	36	+P	50
	51	Fluorochlorocarbons (Pyrotec tube)	7-280	1	Yellow	Reddish purple	36	+P	
	51L	Fluorochlorocarbons (Pyrotec tube)	20-54 1-20	1 2	Yellow	Reddish purple	36	+P	
1,1,2,2-Tetrachloroethane Cl ₂ CHCHCl ₂	131L	Vinyl chloride	2-30	2	Yellow	Reddish brown	30*	+T	1
Tetrachloroethylene Cl ₂ C:CCl ₂	133HA	Tetrachloroethylene	300-900 20-300 7-20	1/2 ① 2	Yellow	Reddish purple	30*	T	25
	133M	Tetrachloroethylene	100-220 5-100 2-5	1/2 ① 2	Yellow	Reddish purple	30*	T	
	133L	Tetrachloroethylene	25-75 2-25 1-2	1/2 ① 2	Yellow	Pink	30*	T	
	133LL	Tetrachloroethylene	3.0-6.6 0.2-3.0 0.1-0.2	1/2 ① 2	Yellow	Purple	24*	T	
	132HH	Trichloroethylene	0.075-1.5%	1	White	Yellowish brown	36	T	

T: Temp Correction H: Humidity Correction ++: Nine Tubes * Refrigerated Storage Mesh: Correction Factor/Chart
P: Use Pyrotec pyrolyzer No. 840 and GASTEC gas sampling pump.
See page 44 for additional symbols and definitions.

Gas or Vapour to be Measured Chemical Formula	Tube No. & Name		Measuring Range (ppm)	No. of Pump Strokes	Colour Change		Shelf Life (month)	Note	TLV-TWA, C (ACGIH) (ppm)
					Original	Stain			
Tetrachloromethane	See Carbon tetrachloride								
Tetrahydrofuran C ₄ H ₈ O	159	Tetrahydrofuran	50-800 25-50	① 2	Pale vermilion	Pale blue	36	T	50
	159L	Tetrahydrofuran	80-232 5-80	1/2 ①	Pale yellow	Pale blue	12 *	T	
	161	Ethyl ether	0.056-1.4%	1	Yellowish brown	Greenish brown	36	T	
Tetrahydrothiophene C ₄ H ₈ S	76H	Tetrahydrothiophene	10-200	1	Pink	Pale yellow	24	+T	
	76	Tetrahydrothiophene	1-10	4	Pink	Pale yellow	24	+T	
	76M	Tetrahydrothiophene	10-100mg/m ³	2	Pink	Pale yellow	24	+T	
Tetramethylenediamine H ₂ N(CH ₂) ₄ NH ₂	180	Amines	8.5-170	1	Pink	Purple to yellow	36	T	
	180L	Amines	0.8-16	1	Pink	Grayish purple (Pale yellowish orange at the end of staining)*:1	36	T	
Thionyl chloride SOCl ₂	5La	Sulphur dioxide	1.44-21.6	2	Blue	Yellow	36		C 0.2
Toluene C ₆ H ₅ CH ₃	122	Toluene	300-690	1/2	White	Brown	36		20
			10-300	①					
			5-10	2					
	122L	Toluene	50-100 2-50 1-2	1 ② 4	White	Brown	36		
161	Ethyl ether	0.02-0.8%	1	Yellowish brown	Greenish brown	36	T		
Toluol	See Toluene								
o-Toluidine C ₆ H ₄ (CH ₃)(NH ₂)	181	Aniline	5-60	2	Pale yellow	Pale green	36		2
Trichloroacetic acid CCl ₃ COOH	15L	Nitric acid	1-37	1	Yellow	Reddish purple	36	H	0.5
1,2,4-Trichlorobenzene C ₆ H ₃ Cl ₃	131La	Vinyl chloride	0.65-13	4	Yellow	Reddish brown	24 *	+	C 5
1,1,1-Trichloroethane (Methyl chloroform) CH ₃ CCl ₃	135	1,1,1-Trichloroethane (Methyl chloroform)	500-2000 100-500	1/2 ①	White	Reddish orange	36	+T	350
			200-900 20-200 6-20	1/2 ① 2					
	171	Acetylene	0.06-1.2%	1	White	Brown	36	T	
1,1,2-Trichloroethane Cl ₂ CHCH ₂ Cl	135	1,1,1-Trichloroethane (Methyl chloroform)	220-750	2	White	Reddish orange	36	+T	10
Trichloroethylene Cl ₂ C:CHCl	132HH	Trichloroethylene	1-2.5% 0.05-1%	1/2 ①	White	Yellowish brown	36	T	10
	132HA	Trichloroethylene	500-1300 50-500 20-50	1/2 ① 2	Yellow	Reddish purple	24 *	T	
			100-270 5-100 2-5	1/2 ① 2					
			25-90 2-25 0.8-2	1/2 ① 2					
	132LL	Trichloroethylene	4.0-8.8 0.25-4.0 0.125-0.25	1/2 ① 2	Yellow	Purple	24 *	T	

T: Temp Correction H: Humidity Correction +: Twin Tubes ++: Nine Tubes * Refrigerated Storage Mesh: Correction Factor/Chart
P: Use Pyrotec pyrolyzer No. 840 and GASTEC gas sampling pump. *:1:Pale yellowish orange when low concentration
See page 44 for additional symbols and definitions.

Gas or Vapour to be Measured Chemical Formula	Tube No. & Name		Measuring Range (ppm)	No. of Pump Strokes	Colour Change		Shelf Life (month)	Note	TLV-TWA, C (ACGIH) (ppm)						
					Original	Stain									
Trichlorofluoromethane (R11) CCl ₃ F	51H	Fluorochlorocarbons (Pyrotec tube)	2200-6600 275-2200	1/2 1	White	Reddish orange	36	+P	C 1000						
	51	Fluorochlorocarbons (Pyrotec tube)	8-320	1	Yellow	Reddish purple	36	+P							
	51L	Fluorochlorocarbons (Pyrotec tube)	16-43.2 0.8-16	1 2	Yellow	Reddish purple	36	+P							
Trichloromethane	See Chloroform														
Trichloronitromethane	See Chloropicrin														
1,2,3-Trichloropropane CH ₂ ClCHClCH ₂ Cl	135L	1,1,1-Trichloroethane (Methyl chloroform)	36-360	4	White	Pale pink	27	+T	0.005						
1,1,2-Trichloro-1,2,2-trifluoroethane (R113) CClF ₂ CCl ₂ F	51H	Fluorochlorocarbons (Pyrotec tube)	2000-6000 250-2000	1/2 ①	White	Reddish orange	36	+P	1000						
	51	Fluorochlorocarbons (Pyrotec tube)	10-400	1	Yellow	Reddish purple	36	+P							
	51L	Fluorochlorocarbons (Pyrotec tube)	20-54 1-20	1 ②	Yellow	Reddish purple	36	+P							
1,1,1-Trichloro-2,2,2-trifluoroethane (R113a) CCl ₃ CF ₃	51H	Fluorochlorocarbons (Pyrotec tube)	1600-4800 200-1600	1/2 1	White	Reddish orange	36	+P							
	51	Fluorochlorocarbons (Pyrotec tube)	10-400	1	Yellow	Reddish purple	36	+P							
	51L	Fluorochlorocarbons (Pyrotec tube)	16-43.2 0.8-16	1 2	Yellow	Reddish purple	36	+P							
Triethylamine (C ₂ H ₅) ₃ N	180	Amines	4.5-90	1	Pink	Yellow	36	T	0.5						
	180L	Amines	0.3-6	1	Pink	Pale yellowish orange	36	T							
Trimethylamine (CH ₃) ₃ N	3M	Ammonia	25-250	1	Purple	Yellow	36		5						
	180	Amines	3.5-70	1	Pink	Yellow	36	T							
	180L	Amines	0.25-5	1	Pink	Pale yellowish orange	36	T							
Trimethyl benzene C ₆ H ₃ (CH ₃) ₃ N	123	Xylene	10-300	2	White	Brown	36		10						
Valeric acid CH ₃ (CH ₂) ₃ COOH	81L	Acetic acid	0.38-15	1	Pink	Pale yellow	24*	T							
Vinyl acetate CH ₃ CO ₂ CH:CH ₂	143	Vinyl acetate	100-250 10-100 5-10	1 ② 4	White	Brown	36	+	10						
			141	Ethyl acetate						0.06-0.9%	1	Yellowish brown	Greenish brown	36	T
Vinyl benzene	See Styrene														
Vinyl chloride CH ₂ :CHCl	131	Vinyl chloride	1-2% 0.05-1% 0.025-0.05%	1/2 ① 2	Yellowish brown	Greenish brown	36		1						
			131LB	Vinyl chloride						20-70 1-20 0.4-1	1 ② 4	Yellow	Purple	24*	T
										131La	Vinyl chloride				
	131L	Vinyl chloride	3-6.9 0.2-3 0.1-0.2	1 ② 4	Yellow	Reddish brown	30*	+T							

T: Temp Correction H: Humidity Correction +: Twin Tubes ++: Nine Tubes * Refrigerated Storage Mesh: Correction Factor/Chart

P: Use Pyrotec pyrolyzer No. 840 and GASTEC gas sampling pump.

See page 44 for additional symbols and definitions.

Gas or Vapour to be Measured Chemical Formula	Tube No. & Name		Measuring Range (ppm)	No. of Pump Strokes	Colour Change		Shelf Life (month)	Note	TLV-TWA, C (ACGIH) (ppm)
					Original	Stain			
Vinyl cyanide	See Acrylonitrile								
Vinylidene chloride CH ₂ :CCl ₂	130L	Vinylidene chloride	14-40.6 1-14 0.4-1	1/2 ① 2	Yellow	Reddish brown	24*	+	5
Vinyl trimethoxysilane CH ₂ :CHSi(OCH ₃) ₃	113L	Isopropyl alcohol	6.5-25.0	2	Pale vermilion	Pale blue	36	T	
Water vapour H ₂ O	6	Water vapour	18-32mg/L 1-18mg/L 0.5-1mg/L	1/2 ① 2	Yellowish green	Purple	36	T	
	6L	Water vapour	1-2mg/L 0.05-1mg/L	1/2 ①	Yellow	Purple	36		
	6LP	Pipeline Dew Point Tube	40-100LB/MMCF 3-40LB/MMCF	1/2 ①	Yellow	※4 Greenish purple	36	T	
	6LLP	Pipeline Dew Point Tube	2-10LB/MMCF	2	Yellow	Green	36	T	
Xylene C ₆ H ₄ (CH ₃) ₂	123	Xylene	250-625 10-250 5-10	1/2 ① 2	White	Brown	36		20
	123L	Xylene	100-200 2-100	1 ②	White	Brown	36		
	100A	LPG	0.1-1.2%	2	Yellowish brown	Greenish brown	36		
	122L	Toluene	100-200 4-100 2-4	1 2 4	White	Brown	36		

T: Temp Correction H: Humidity Correction +: Twin Tubes ++: Nine Tubes * Refrigerated Storage Mesh: Correction Factor/Chart

LB / MMCF = Pound / Million Cubic Feet (1mg/L = 62.3LB / MMCF)

※4 May become "Purple" with high humidity. P: Use Pyrotec pyrolyzer No. 840 and GASTEC gas sampling pump.

See page 44 for additional symbols and definitions.

Passive Dosi-tubes (Time Weighted Average Detector Tubes)

Gas or Vapour to be Measured Chemical Formula	Tube No. & Name		Measuring Range (ppm)	Measuring Time (hours)	Colour Change		Shelf Life (month)	Note	TLV-TWA, C (ACGIH) (ppm)
					Original	Stain			
Acetaldehyde CH ₃ CHO	91D	Formaldehyde	0.1-20	1-10	Yellow	Reddish brown	12 *		C 25
	151D	Acetone	4-1200	1-10	Yellow	Reddish brown	24 *	T	
	152D	Methyl ethyl ketone	1.2-360	1-10	Yellow	Reddish brown	24 *	T	
Acetic acid CH ₃ CO ₂ H	81D	Acetic acid	0.5-100	1-10	Purple	Yellow	36	T	10
Acetic anhydride (CH ₃ CO) ₂ O	81D	Acetic acid	0.3-60	1-10	Purple	Yellow	36	T	1
Acetone CH ₃ COCH ₃	151D	Acetone	5-1500	1-10	Yellow	Reddish brown	24 *	T	250
	152D	Methyl ethyl ketone	1.4-420	1-10	Yellow	Reddish brown	24 *	T	
Ammonia NH ₃	3D	Ammonia	2.5-1000	0.5-10	Purple	Yellow	36	T	25
	3DL	Ammonia	0.1-10	1-10	Pink	Yellow	24	TH	
Benzene C ₆ H ₆	122DL	Toluene	2.4-600	1-10	White	Brown	24		0.5
1,3-Butadiene CH ₂ :CHCH:CH ₂	174D	1,3-Butadiene	1.3-200	1-8	Reddish purple	Pale brown	30	T	2
Carbon dioxide CO ₂	2D	Carbon dioxide	0.02-12%	0.5-10	Pale vermilion	Yellow	30	T	5000
Carbon monoxide CO	1D	Carbon monoxide	1.04-2000	0.5-48	Pale yellow	Brown	24		25
	1DL	Carbon monoxide	0.4-400	0.5-24	Pale yellow	Brown	24 *		
Chlorine Cl ₂	8D	Chlorine	0.08-100	0.5-24	White	Yellow	24		0.1
	132D	Trichloroethylene	2.4-240	1-8	Yellow	Purple	15 *	T	
Cumene C ₆ H ₅ CH(CH ₃) ₂	122DL	Toluene	3.4-850	1-10	White	Brown	24		5
trans-1,2-Dichloroethylene ClCH:CHCl	174D	1,3-Butadiene	3.8-600	1-8	Reddish purple	Pale brown	30	T	200
1,2-Dichloroethylene ClCH:CHCl	132D	Trichloroethylene	6-600	1-8	Yellow	Purple	15 *	T	200
Dimethylamine (CH ₃) ₂ NH	3D	Ammonia	1.9-750	0.5-10	Purple	Yellow	36	T	5
N,N-Dimethylethylamine C ₂ H ₅ N(CH ₃) ₂	3D	Ammonia	4-1600	0.5-10	Purple	Yellow	36	T	
Ethanol C ₂ H ₅ OH	112D	Ethanol	100-25000	1-10	Yellow	Brown	36		STEL 1000
Ethyl benzene C ₆ H ₅ C ₂ H ₅	122DL	Toluene	2.8-700	1-10	White	Brown	24		20
Ethylene CH ₂ :CH ₂	174D	1,3-Butadiene	1.5-240	1-8	Reddish purple	Pale brown	30	T	200
Formaldehyde HCHO	91D	Formaldehyde	0.1-20	1-10	Yellow	Reddish brown	12 *		0.1
Formic acid HCO ₂ H	81D	Acetic acid	0.55-110	1-10	Purple	Yellow	36	T	5
Furfural C ₅ H ₄ O ₂	91D	Formaldehyde	0.3-60	1-10	Yellow	Reddish brown	12 *		0.2
Hydrazine N ₂ H ₄	3D	Ammonia	1.6-650	0.5-10	Purple	Yellow	36	T	0.01
Hydrogen chloride HCl	14D	Hydrogen chloride	1-100	1-10	Yellow	Purple	36	TH	C 2
	132D	Trichloroethylene	1.8-180	1-8	Yellow	Purple	15 *	T	
	17D	Hydrogen fluoride	0.4-40	1-10	Yellow	Purple	36	TH	
Hydrogen cyanide HCN	12D	Hydrogen cyanide	1-200	1-10	Yellow	Pink	24		C 4.7
Hydrogen fluoride HF	17D	Hydrogen fluoride	1-100	1-10	Yellow	Purple	36	TH	0.5
	14D	Hydrogen chloride	2.5-250	1-10	Yellow	Purple	36	TH	
Hydrogen peroxide H ₂ O ₂	32D	Hydrogen peroxide	0.5-40	1-10	White	Yellow	36	T	1

T: Temp Correction H: Humidity Correction * Refrigerated Storage Mesh: Correction Factor/Chart
See page 44 for additional symbols and definitions.

Gas or Vapour to be Measured Chemical Formula	Tube No. & Name		Measuring Range (ppm)	Measuring Time (hours)	Colour Change		Shelf Life (month)	Note	TLV-TWA, C (ACGIH) (ppm)
					Original	Stain			
Hydrogen sulphide H ₂ S	4D	Hydrogen sulphide	0.2-200	1-48	White	Brown	36		1
Isoprene CH ₂ :C(CH ₃)CH:CH ₂	174D	1,3-Butadiene	2.5-400	1-8	Reddish purple	Pale brown	30	T	
Methylamine CH ₃ NH ₂	3DL	Ammonia	0.19-19	1-10	Pink	Yellow	24	TH	5
Methyl ethyl ketone CH ₃ COC ₂ H ₅	152D	Methyl ethyl ketone	2-600	1-10	Yellow	Reddish brown	24 *	T	200
	91D	Formaldehyde	0.125-25	1-10	Yellow	Reddish brown	12 *		
	151D	Acetone	6.5-1950	1-10	Yellow	Reddish brown	24 *	T	
Methyl isobutyl ketone (CH ₃) ₂ CHCH ₂ COCH ₃	151D	Acetone	11.5-3450	1-10	Yellow	Reddish brown	24 *	T	20
	152D	Methyl ethyl ketone	4-1200	1-10	Yellow	Reddish brown	24 *	T	
Nitric acid HNO ₃	14D	Hydrogen chloride	0.8-80	1-10	Yellow	Purple	36	TH	2
	17D	Hydrogen fluoride	0.32-32	1-10	Yellow	Purple	36	TH	
Nitrogen dioxide NO ₂	9D	Nitrogen dioxide	0.1-30	1-10	White	Yellow	12 *	T	0.2
	9DL	Nitrogen dioxide	0.01-3.0	1-24	White	Green	12 *		
Styrene C ₆ H ₅ CH:CH ₂	122DL	Toluene	26-6500	1-10	White	Brown	24		10
Sulphur dioxide SO ₂	5DH	Sulphur dioxide	10-600	1-5	Bluish purple	White	36	T	STEL 0.25
	5D	Sulphur dioxide	0.2-100	1-10	Green	Yellow	36		
Tetrachloroethylene Cl ₂ C:CCl ₂	133D	Tetrachloroethylene	3-150	1-8	Yellow	Purple	15 *	T	25
	132D	Trichloroethylene	1.5-150	1-8	Yellow	Purple	15 *	T	
Toluene C ₆ H ₅ CH ₃	122DL	Toluene	2-500	1-10	White	Brown	24		20
Trichloroethylene Cl ₂ C:CHCl	132D	Trichloroethylene	3-300	1-8	Yellow	Purple	15 *	T	10
Triethylamine (C ₂ H ₅) ₃ N	3D	Ammonia	5.3-2100	0.5-10	Purple	Yellow	36	T	0.5
Trimethylamine (CH ₃) ₃ N	3DL	Ammonia	0.23-23	1-10	Pink	Yellow	24	TH	5
Vinyl chloride CH ₂ :CHCl	174D	1,5-Butadiene	1.5-240	1-8	Reddish purple	Pale brown	30	T	1
Xylene C ₆ H ₄ (CH ₃) ₂	122DL	Toluene	3.4-850	1-10	White	Brown	24		20

T: Temp Correction H: Humidity Correction * Refrigerated Storage Mesh: Correction Factor/Chart
See page 44 for additional symbols and definitions.

Measurement procedure

- Write down the starting time of measurement on an adhesive label included inside each box of Dosi-tubes, and place the label onto the tube.
- Insert the G marked end of the Dosi-tube into the No.710 Tube Holder, and break the tube end at the breaking line (A). Remove the broken end from the Tube holder.

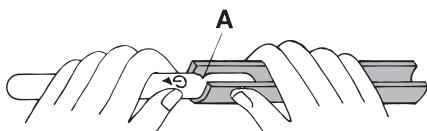

- Insert the Dosi-tube fully into the Tube holder.

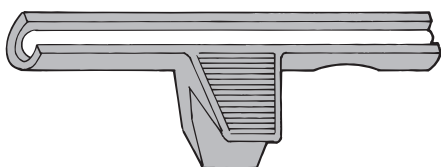

- Attach the Tube Holder with the Dosi-tube to the shirt collar for personal sampling, or put it on an appropriate measurement point in the workplace for area monitoring.
- When the measurement is finished, write down the finishing time on the label, and determine the actual sampling time :
= (finishing time) - (starting time)
- Obtain the average concentration (TWA value) by the following formula.

$$\text{TWA value (ppm)} = \frac{\text{Dosi-tube reading (ppm} \cdot \text{hr)}}{\text{Actual sampling time (hr)}}$$

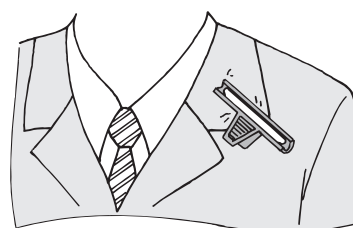

■ 30m Extension hose No.351A-30

The extension hose are available to be attached to the inlet of the gas sampling pump and used for remote downward (30m) measurement.

* For twin tube operation, order the Extension hose guard rubber (No.358). When the extension hose tip needs to be replaced, order the Replacement extension hose guard rubber (No.359).

Currently only the detector tubes listed below are applicable to No. 351A-30. If you need to use other tube, please contact your Gastec representatives.

Gas or Vapour to be Measured	Chemical Formula	Tube No. & Name		Measuring Range (ppm)	Shelf Life (month)	Note
Acetaldehyde	CH ₃ CHO	92M	Acetaldehyde	2.5—100	24 *	F
Acetic acid	CH ₃ CO ₂ H	81L	Acetic acid	0.125—23	24 *	TF
Acetone	CH ₃ COCH ₃	151L	Acetone	50—12000	24 *	T
Acrylonitrile	CH ₂ :CHCN	191L	Acrylonitrile	0.1—18	36	+
Ammonia	NH ₃	3M	Ammonia	10—1000	36	
		3La	Ammonia	2.5—220	36	T
		3L	Ammonia	0.5—78	36	TF
Aromatic hydrocarbons		120	Aromatic hydrocarbons	0.4—200	36	F
Arsine	AsH ₃	19LA	Arsine	0.04—10	27	
Benzene	C ₆ H ₆	121S	Benzene	2—312	36	+F
		121	Benzene	2.5—120	36	F
		121SL	Benzene	1—100	36	+F
		121L	Benzene	0.1—65	36	+F
1,3-Butadiene	CH ₂ :CHCH:CH ₂	174	1,3-Butadiene	50—800	36	T
		174L	1,3-Butadiene	2.5—100	36	
Butyl acetate	CH ₃ CO ₂ (CH ₂) ₃ CH ₃	142L	Butyl acetate	10-300	24	TF
tert-Butyl mercaptan	(CH ₃) ₃ CSH	75N	tert-Butyl mercaptan	1.25—250mg/m ³	24	TH
		75LN	tert-Butyl mercaptan	0.5—39mg/m ³	24 *	THF
Carbon dioxide	CO ₂	2HH	Carbon dioxide	2.5—40%	36	F
		2H	Carbon dioxide	0.5—20%	36	F
		2L	Carbon dioxide	0.13—6%	36	
		2LL	Carbon dioxide	300—5000	36	
		2LC	Carbon dioxide	100—4000	24	
Carbon monoxide	CO	1L	Carbon monoxide	2.5—2000	36	F
		1LK	Carbon monoxide	5—600	36	
		1LL	Carbon monoxide	5—50	36	F
Chloropicrin	Cl ₃ CNO ₂	134	Carbon tetrachloride	2.5—60	12 *	+F
		134L	Carbon tetrachloride	0.28—5.5	12 *	+F
		233	Chloropicrin	0.045—22	12	+F
Cyclohexanol	C ₆ H ₁₁ OH	118	Cyclohexanol	5—100	24	TF
1,2-Dichloroethylene	CICH ₂ :CHCl	139	1,2-Dichloroethylene	5—250	30 *	T
1,3-Dichloropropene	CICH ₂ CH:CHCl	131La	Vinyl chloride	0.5—10	24 *	+F
Dichlorvos	C ₄ H ₇ Cl ₂ O ₄ P	132LL	Trichloroethylene	0.11—1.8	24 *	TF
Ethanol	C ₂ H ₅ OH	112	Ethanol	0.01—7.5%	36	TF
		112L	Ethanol	50—2000	36	TF
Ethyl acetate	CH ₃ CO ₂ C ₂ H ₅	141L	Ethyl acetate	20—800	24	T
Ethylene	CH ₂ :CH ₂	172	Ethylene	25—1680	36	TF
		172L	Ethylene	0.2—100	36	TF
Ethylene dichloride	CICH ₂ CH ₂ Cl	232	1,2-Dichloroethane	1—39	12 *	+TF
Ethylene glycol	HOCH ₂ CH ₂ OH	165L	Ethylene glycol	10—100mg/m ³	36 *	+TF
Ethyl mercaptan	C ₂ H ₅ SH	72	Ethyl mercaptan	0.5—120	36	TF
		72LN	Ethyl mercaptan	0.15—57.5	24	T
Ethylene oxide	C ₂ H ₄ O	163	Ethylene oxide	0.05—3.0%	36	F
		163L	Ethylene oxide	0.4—550	12 *	+TF
		163LL	Ethylene oxide	0.1—10	12 *	+TF
Ethyl ether	(C ₂ H ₅) ₂ O	161	Ethyl ether	0.04—1%	36	TF
Formaldehyde	HCHO	91L	Formaldehyde	0.1—45.0	36 *	TF
Gasoline	C _n H _m	101L	Gasoline	30—2000	36	F
Hexane	CH ₃ (CH ₂) ₄ CH ₃	102L	Hexane	3.5—1200	36	F
Hydrocarbons (Higher class)		105	Hydrocarbons (Higher class)	100—3000	36	
Hydrocarbons (Lower class)		103	Hydrocarbons (Lower class)	0.05—2.4%	30	++
Hydrogen	H ₂	30	Hydrogen	0.5—2%	36	
Hydrogen sulphide	H ₂ S	4HH	Hydrogen sulphide	0.1—4%	36	
		4H	Hydrogen sulphide	10—4000	36	
		4HM	Hydrogen sulphide	25—1600	36	
		4M	Hydrogen sulphide	12.5—500	36	
		4L	Hydrogen sulphide	1—240	36	
		4LL	Hydrogen sulphide	0.25—120	36	
		4LK	Hydrogen sulphide	1—40	36	

T: Temp Correction H: Humidity Correction +: Twin Tubes ++: Nine Tubes * Refrigerated Storage

F: Correction factors might be applied when using No. 351A-30. See No. 351A-30 instruction manual for details. Measuring ranges above will be changed in case correction factors are applied.

Gas or Vapour to be Measured	Chemical Formula	Tube No. & Name		Measuring Range (ppm)	Shelf Life (month)	Note
Hydrogen sulphide	H ₂ S	4LB	Hydrogen sulphide	0.5—12	24	
		4LT	Hydrogen sulphide	0.05—4.0	24 *	
Isoamyl alcohol	(CH ₃) ₂ CHCH ₂ CH ₂ OH	117	Isoamyl alcohol	5—300	36	TF
LPG		100A	LPG	0.02—0.8%	36	
Mercaptans	R · SH	70	Mercaptans	0.5—120	36	T
		70L	Mercaptans	0.1—8	24	
		70LN	Mercaptans	0.1—8	24 *	
Mercury vapour	Hg	40	Mercury vapour	0.05—13.2mg/m ³	36	F
Methanol	CH ₃ OH	111	Methanol	0.002—6.0%	36	TF
		111L	Methanol	20—1000	36	TF
Methyl bromide	CH ₃ Br	136H	Methyl bromide	10—600	36	+
		136L	Methyl bromide	2.5—200	27	+
		136LA	Methyl bromide	1—36	36	+F
		136LL	Methyl bromide	0.1—3.0	24	+T
Methyl tert-butyl ether	CH ₃ OC(CH ₃) ₃	166	Methyl tert-butyl ether	10-660	24	T
Methyl iodide	CH ₃ I	230H	Methyl iodide	100—34800	24	TF
		230	Methyl iodide	0.5—108	24 *	TF
Methyl isothiocyanate	CH ₃ NCS	141L	Ethyl acetate	5.4—216	24	TF
		234L	Methyl isothiocyanate	0.07-25	24	+TF
Nitric acid	HNO ₃	15L	Nitric acid	0.1—40	36	HF
Nitrogen dioxide	NO ₂	9L	Nitrogen dioxide	0.5—125	36	F
Nitrogen oxides	NO+NO ₂	11L	Nitrogen oxides	0.03—14	36	F
Petroleum naphtha		106	Petroleum naphtha	0.5—28mg/L	36	
Phenol	C ₆ H ₅ OH	60	Phenol	0.12—183	24 *	TF
Phosphine	PH ₃	7H	Phosphine	200—5500	36	T
		7J	Phosphine	2.5—1000	36	F
		7	Phosphine	2.5—100	36	
		7L	Phosphine	0.15—5	36	
		7LA	Phosphine	0.05—9.8	24	
Styrene	C ₆ H ₅ CH:CH ₂	124	Styrene	10—1500	36	F
		124L	Styrene	2—100	36	F
Sulphur dioxide	SO ₂	5La	Sulphur dioxide	0.5—60	36	
		5LC	Sulphur dioxide	0.1—22	36	T
		5Lb	Sulphur dioxide	0.05—10.0	36	F
Sulphuric acid	H ₂ SO ₄	35	Sulphuric acid	0.5—5mg/m ³	24	T
Sulphuryl fluoride	SO ₂ F ₂	231	Sulphuryl fluoride	1—20	24	+T ※6
Toluene	C ₆ H ₅ CH ₃	122	Toluene	5—690	36	F
		122L	Toluene	1—100	36	F
1,1,1-Trichloroethane	CH ₃ CCl ₃	135	1,1,1-Trichloroethane	100—2000	36	+T
Vinyl chloride	CH ₂ :CHCl	131	Vinyl chloride	0.025—2.0%	36	F
		131LB	Vinyl chloride	0.4—70	24 *	TF
		131La	Vinyl chloride	0.25—54	24 *	+
		131L	Vinyl chloride	0.1—6.9	30 *	+TF
Water vapour	H ₂ O	6L	Water vapour	0.05—2.0mg/L	36	
Xylene	C ₆ H ₄ (CH ₃) ₂	123	Xylene	5—625	36	F
		123L	Xylene	2—200	36	F

T: Temp Correction H: Humidity Correction +: Twin Tubes ++: Nine Tubes * Refrigerated Storage ※6: for four test
F: Correction factors might be applied when using No. 351A-30. See No. 351A-30 instruction manual for details.
Measuring ranges above will be changed in case correction factors are applied.

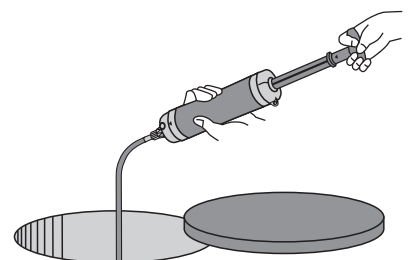

■ Sulphuryl fluoride measurement system

GASTEC developed the Pyrotec pyrolyzer system to enable precise and easy detection of Sulphuryl fluoride. It converts Sulphuryl fluoride (using a process known as thermal cracking) into an easily measurable gas.

* Use Sulphuryl fluoride pyrotube No. 231, Pyrotec pyrolyzer No. 860, and GASTEC gas sampling pump.

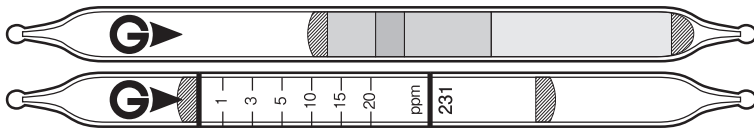

Gas or Vapour to be Measured Chemical Formula	Tube No. & Name		Measuring Range (ppm)	No. of Pump Strokes	Colour Change		Shelf Life (month)	Note
					Original	Stain		
Sulphuryl fluoride SO ₂ F ₂	231	Sulphuryl fluoride	1-20	3	Bluish purple	White	24	+T ※5

T: Temp Correction +: Twin Tubes ※5 for four test

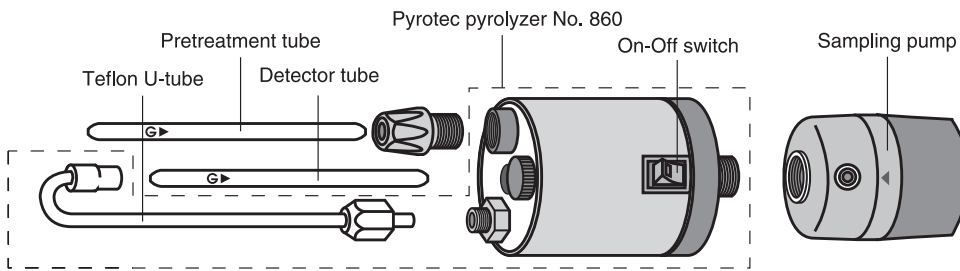

■ Qualitative analysis system for inorganic/organic gas qualitative detector tubes

Gas or Vapour to be Measured	Tube No. & Name		Measuring Range (ppm)	No. of Pump Strokes	Colour Change		Shelf Life (month)
					Original	Stain	
NH ₃ , SO ₂ , H ₂ S, CO, NO ₂ , R.SH	25	Polytec tube-II	Qualitative analysis	1	Qualitative analysis		24
NH ₃ , H ₂ S, CnHm	26	Polytec tube-III	Qualitative analysis	1	Qualitative analysis		24
NH ₃ , HCl, H ₂ S, SO ₂ , NO ₂ , CO, CO ₂	27	Polytec tube-IV	Qualitative analysis	1	Qualitative analysis		18
HCl, COCl ₂ , SO ₂ , NO ₂ , H ₂ S, HCN, CO, CO ₂	28	Polytec tube-V	Qualitative analysis	1	Qualitative analysis		18
Unknown Gases	107	Polytec tube-I	Qualitative analysis	3	Qualitative analysis		36
Kerosene, Gasoline	108	Qualitative analysis tube for fire investigation	Qualitative analysis	1	Qualitative analysis		36

The Gastec polytec system consists of the Model GV-100S Gas sampling pump and the Polytec tubes. The Polytec tubes are unique detector tubes, each having 1 to 8 reaction layers to determine multiple unknown substances in the sample simultaneously. When you pull the handle of the Pump and wait for a predetermined sampling time, the colour (s) of the Polytec tube's layer (s) change uniquely according to the contents of the sample. Six types of Polytec tubes are available: Polytec I (No.107), Polytec II (No.25), Polytec III (No.26), Polytec IV (No.27), Polytec V (No.28), and Qualitative analysis tube for fire investigation (No.108). Detailed descriptions are given in the instruction sheets included with individual Polytec tubes. If you already have the Model GV-100S gas sampling pump, you need only to obtain the desired Polytec tubes.

■ Polytec I (No. 107)



■ Qualitative analysis tube for fire investigation (No. 108)



Example :

■ Polytec V (No. 28)

Detecting layer	1	2	3	4	5	6	7	8
Original colour	Pale yellow	White	Blue	White	White	Yellow	Yellow	Blue
Colour change	Red	Yellow	Yellow	Yellow	Brown	Pink	Blackish brown, Gray, Yellowish orange	Brown
Substance	Hydrogen chloride	Phosgene, Chlorine, Nitrogen dioxide	Sulphur dioxide	Nitrogen dioxide	Hydrogen sulphide	Hydrogen sulphide, Hydrogen cyanide, Hydrogen phosphide	Carbon monoxide, Hydrogen, Hydrogen phosphide, Acetylene, Ethylene, Propylene, Methyl mercaptan	Carbon dioxide

■ Polytec IV (No. 27)

Detecting layer	1	2	3	4	5	6	7
Original colour	Purple	Yellow	White	Blue	White	Yellow	Blue
Colour change	Yellow	Red	Brown	Yellow, Purple	Yellow, Yellowish orange	Blackish brown, Gray, Yellowish orange	Brown
Substance	Ammonia, Diethylamine	Hydrogen chloride	Hydrogen sulphide	Chlorine, Sulphur dioxide, Nitrogen dioxide	Chlorine, Nitrogen dioxide	Hydrogen sulphide, Carbon monoxide, Hydrogen, Phosphine, Acetylene, Ethylene, Propylene, Methyl mercaptan	Carbon dioxide

■ Polytec II (No. 25)

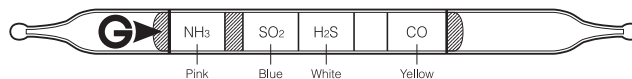

■ Polytec III (No. 26)

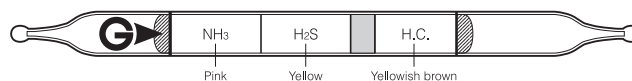

■ Polytec IV (No. 27)

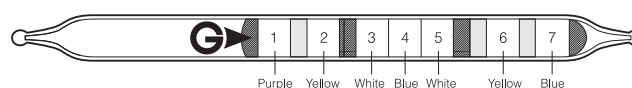

■ Polytec V (No. 28)

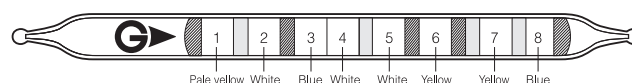

Injection method detector tubes

Gas or Vapour to be Measured	Chemical Formula	Tube No. & Name		Measuring Range (ppm)	Sampling Volume	Colour Change		Shelf Life (month)
						Original	Stain	
Carbon dioxide	CO ₂	2HT	Carbon dioxide	10-100%	20mL/20sec.	White	Purple	36
Propane	CH ₃ CH ₂ CH ₃	100B	Propane	0.1-2%	20mL/120sec.	Brown	Blackish green	36

① Break off both ends of a detector tube (No.100B for No.601 syringe or No.2HT for No.611 syringe) by using the tube tip cutter.

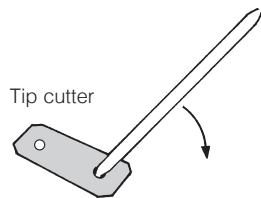

② Attach the syringe inlet to the syringe (No.601 or No.611) and collect 20mL of sample into the syringe by pulling its piston.

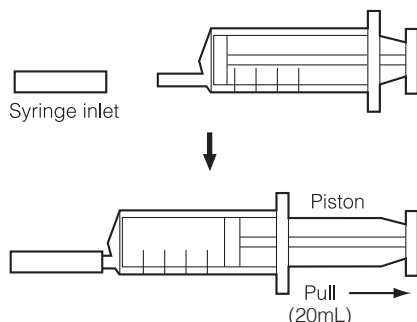

③ Insert the tube securely into the syringe inlet with the arrow pointing away from the syringe. Inject the sample collected in the syringe into the detector tube in 2 minutes (for No.100B) or 20 seconds (for No.2HT), and read the indication.

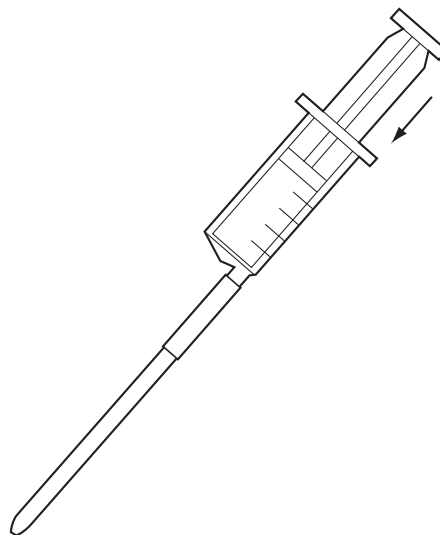

Detector tubes for dissolved substances in solution

Substance to be Measured	Chemical Formula	Tube No. & Name		Measuring Range (ppm)	Sampling Method	Colour Change		Shelf Life (month)
						Original	Stain	
Sulphide ion in solution	S ²⁻	211H	Sulphide ion tube	10-1000	Immersion	White	Brown	36
		211M	Sulphide ion tube	2-300	Immersion	White	Brown	36
		211	Sulphide ion tube	1-100	Immersion	White	Brown	36
		211LL	Sulphide ion tube	0.5-20	Immersion	White	Brown	36
Ozone in solution	O ₃	218	Ozone tube	1-10mg/L	Immersion	Pale blue	White	36
Bromide ion in solution	Br ⁻	221L	Chloride ion tube	55-2200mg/L	Immersion	Brown	White	36
		221LL	Chloride ion tube	24-480mg/L	Immersion	Brown	White	36
Chloride ion in solution	Cl ⁻	221L	Chloride ion tube	25-1000mg/L	Immersion	Brown	White	36
		221LL	Chloride ion tube	10-200mg/L	Immersion	Brown	White	36
Free residual chlorine	ClO ⁻	222	Free residual chlorine tube	0.1-10mg/L	Immersion	White	Reddish orange	30
Mercury in solution	Hg ²⁺	271	Mercury tube	1-20mg/L	Immersion	Pale orange	Bluish purple	36
Chromium (VI) in solution	Cr ⁶⁺	273	Chromium (VI) tube	0.5-50mg/L	Immersion	White	Yellow	36
Iron in solution	Fe ²⁺	281	Iron tube	5-50mg/L	Immersion	White	Orange	36
Copper in solution	Cu ⁺ +Cu ²⁺	284	Copper tube	1-20mg/L	Immersion	White	Orange	24 *
Zinc in solution	Zn ²⁺	285	Zinc tube	3-20mg/L	Immersion	Pale orange	Reddish purple	36
Nickel in solution	Ni ²⁺	291	Nickel tube	5-50mg/L	Immersion	White	Red	36

*Refrigerated Storage

Dissolved substance in solution can be measured by simply immersing the above Gastec tube into a solution. When the detector tube is immersed vertically, (▶) tube arrow pointing upward, the solution will rise up through the tube due to capillary action and react with the reagent in the tube.

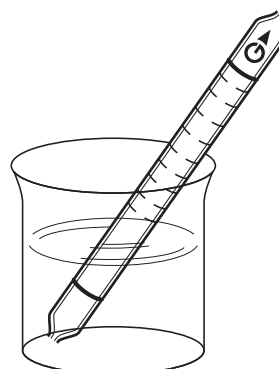

■ Airtec tube - Compressed breathing air detector tubes

Gas or Vapour to be Measured	Chemical Formula	Tube No. & Name		Measuring Range (ppm)	Flow Rate (mL/min)	Sampling Time (min)	Colour Change		Shelf Life (month)
							Original	Stain	
Carbon monoxide	CO	1A	Carbon monoxide Airtec tube	5-50	100	3	Yellow	Blackish brown	36
Carbon dioxide	CO ₂	2A	Carbon dioxide Airtec tube	250-3000	100	5	Yellowish orange	Yellow	36
		2Ag	Carbon dioxide Airtec tube	200-3000	100	1.5	Pale blue	Purple	36
Water vapour	H ₂ O	6AH	Water vapour Airtec tube	500-5000	300	1	Green	Purple	36
		6A	Water vapour Airtec tube	10-80mg/m ³	100	5	Yellow	Green	36
		6Ag	Water vapour Airtec tube	150-3000mg/m ³	300	1	Green	Purple	36
Nitrogen oxides	NO+NO ₂	11A	Nitrogen oxides Airtec tube	0.06-2	100	2	White	Bluish green	36
				0.02-0.7	100	5			
Oil mist		109AD	Oil mist Airtec tube	0.2-5.0mg/m ³	1000	20	Pale vermillion	Pale blue	24
				0.1-0.2mg/m ³	1000	40			
		109A	Oil mist Airtec tube	0.3-1.5mg/m ³	1000	60	White	Greenish brown	30

Gastec Airtec Tube allows anyone to simply, quickly, and quantitatively measure the quality of their compressed breathing air. Easy to use, the Airtec tube is an accurate and precise method for detecting CO, CO₂, Water vapour, Nitrogen oxides and Oil mist. Using Airtec tube direct reading vapour tubes, simply connect the pressure reducer to your high pressure air source, compressor, cylinder, or air line and adjust the flowmetre to the required setting.

When self-contained breathing apparatus or other devices are used for respiratory protection, the quality of the breathing air requires special attention. Contaminants entering the compressor or contaminants generated by the compressor can be harmful to the worker and the respiratory equipment.

Airtec tube is a convenient economical system for testing the quality of your compressed breathing air. You do not have to learn how to operate and calibrate sophisticated instrumentation. With Airtec Tube, the measurement is quick and simple and does not require user calibration. Just snap off both "break away" ends of the tube, insert the tube into the tube holder with the directional arrow pointing down, and adjust the flowmetre to the specified flow rate. After the required time, note where the colour stain stops and take the measurement from the direct reading tube.

■ Measurement procedure: (a case of contaminant test in cylinder)

- ① Attach a pressure reducer with gauge and flow metre to a cylinder, compressor or air line and adjust the flow metre to the required setting.
- ② Break the tips off a fresh detector tube using the tube tip breaker and insert the tube into a tube holder.

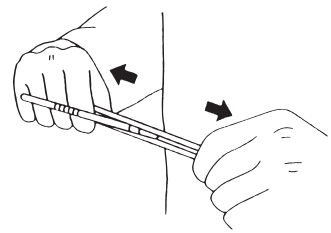
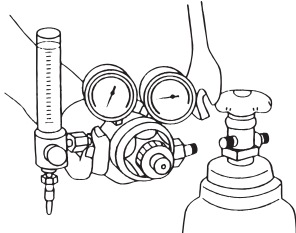

- ③ Attach the rubber tube holder to the flow metre outlet. Make sure the tube arrow  on the tube is pointing in the downward direction.
- ④ Turn on the cylinder or compressor and confirm the flow metre according to each Airtec tube specifications.

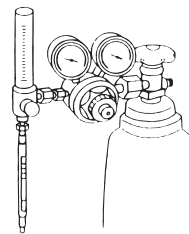
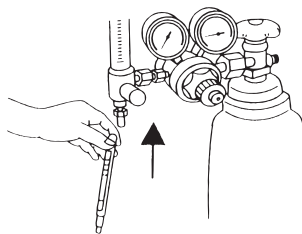

- ⑤ Time the sampling with a stopwatch.
- ⑥ As soon as the sampling time has finished, turn off the cylinder or compressor, and remove the tube from the tube holder and then read the colour-changed layer immediately.



Compressed breathing air measurement kit (CG-1 System)

Gastec CG-1 system can simply, quickly, and simultaneously measure 4 kinds of harmful contaminants (CO, CO₂, Water vapour, and Oil mist) contained in compressed breathing air (cylinder or compressor).

Gas or Vapour to be Measured	Chemical Formula	Tube No. & Name		Measuring Range (ppm)	Flow Rate (mL/min)	Sampling Time (min)	Colour Change		Shelf Life (month)
							Original	Stain	
Carbon monoxide	CO	1A	Carbon monoxide Airtec tube	5-50	100	5	Yellow	Blackish brown	36
Carbon dioxide	CO ₂	2A	Carbon dioxide Airtec tube	250-3000	190	5	Yellowish orange	Yellow	36
Water vapour	H ₂ O	6A	Water vapour Airtec tube	10-80mg/m ³	120	5	Yellow	Green	36
Oil mist		109AD	Oil mist Airtec tube	0.2-5.0mg/m ³	3000	10	Pale vermillion	Pale blue	24
				0.1-0.2mg/m ³	3000	20			

Measurement procedure

STEP.1

1. Connect the measuring device to the pressure reducer fully until it is locked. (Don't connect rubber shrouds)
2. Slowly open the compressed air supply and wait 1 minute.
3. Close the compressed air supply completely, and wait 6 minutes.
4. Confirm the pressure drop is less than 5%.

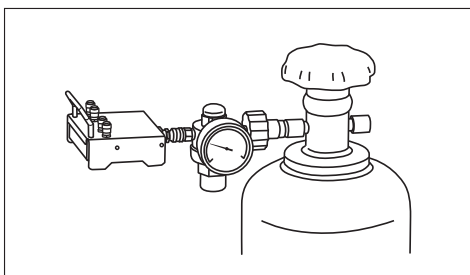

STEP.2

1. With the main valve closed, connect each Rubber shroud to the measuring device fully until it is locked. (Air escapes from the measuring device)

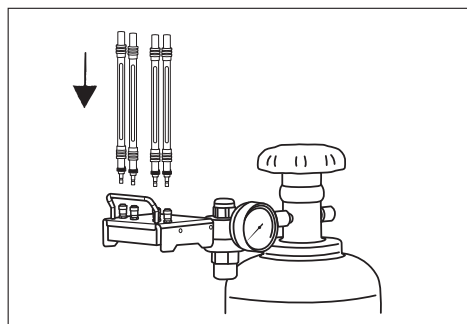

STEP.3

1. Slowly open the compressed air supply valve and clean the air supply system. (disperse compressed air)
2. Wait 5 minutes and close the valve.

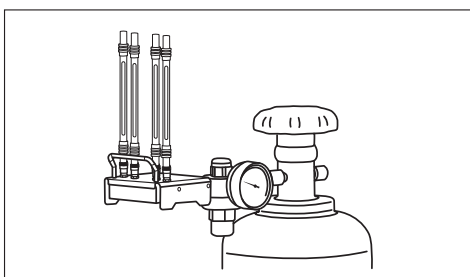

STEP.4

1. Break off both tips of the Gastec tube with the tube tip holder.
2. Set the Gastec tubes in the rubber shrouds according to the markings on the measuring device. Make sure that both ends of the tubes are firmly covered by the rubber shrouds.
3. Open the valve of the compressed air source to start the measurement. Time the sampling with the stopwatch.

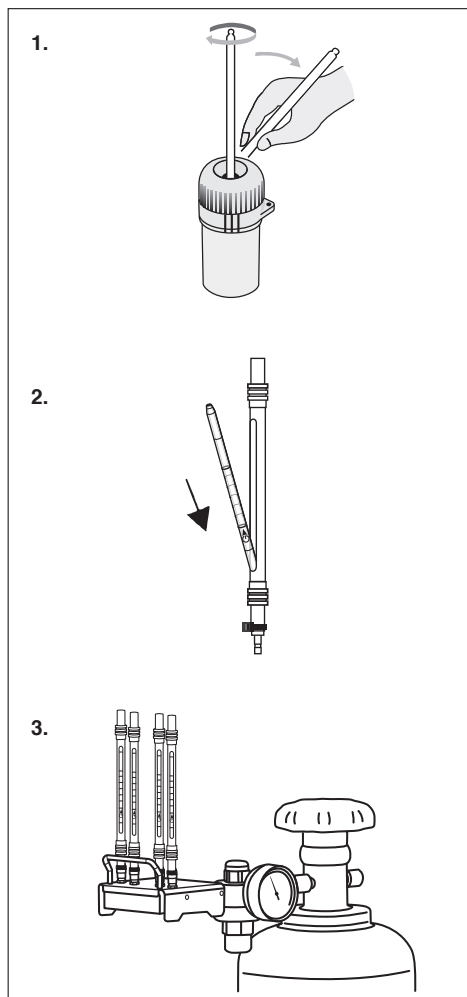

STEP.5

1. After 5 minutes, disconnect the three rubber shrouds(No.1A,2A, and 6A) from the measuring device.
2. After 10 minutes, disconnect the rubber shroud (No.109AD) from the measuring device.
3. Remove the tubes from the rubber shrouds, and read the value of each tube immediately.

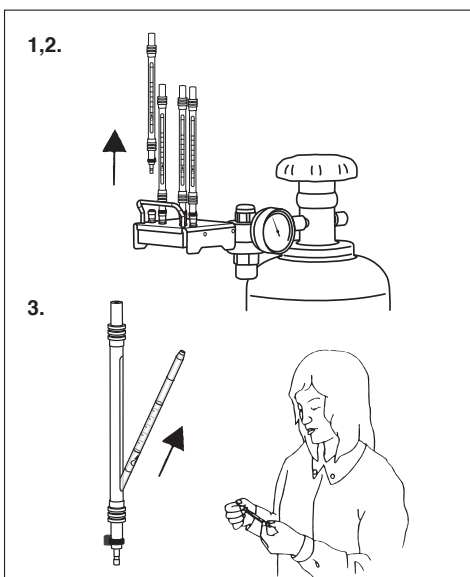

■ Detector tubes for Automatic Air Sampling Pump

Gas or Vapour to be Measured	Chemical Formula	Tube No. & Name		Measuring Range (ppm)	Flow Rate (mL/min)	Sampling Time (min)	Colour Change		Note	Shelf Life (month)
							Original	Stain		
Acetone	CH ₃ COCH ₃	151TP	Acetone	25-800	100	10	Yellow	Red	T	27*
Acrylonitrile	CH ₂ :CHCN	191TP	Acrylonitrile	3.0-12.6	50	10	Yellow	Pink	+T	24
				0.2-3.0	100	10				
Ammonia	NH ₃	3S	Ammonia	0.5-5	150	5	Pink	Yellow		36
Benzene	C ₆ H ₆	121P	Benzene	250-3000µg/m ³	50	60	White	Brown	+	30
		121TP	Benzene	5-14.5 0.1-5	50 100	10 10	White	Brown	+	27
Carbon disulphide	CS ₂	13TP	Carbon disulphide	1.0-2.4	50	10	Blue	Yellowish green	+	24
				0.05-1.0	100	10				
Chlorine	Cl ₂	8TP	Chlorine	0.05-0.6	100	10	Pink	White		30
p-Dichlorobenzene	C ₆ H ₄ Cl ₂	127P	p-Dichlorobenzene	100-3000µg/m ³	100	30	Yellow	Pale reddish purple	+T	24
N,N-Dimethylacetamide	CH ₃ CON(CH ₃) ₂	183TP	N,N-Dimethylformamide	3.0-57.5	100	10	Pink	Yellow	T	24
N,N-Dimethylformamide	HCON(CH ₃) ₂	183TP	N,N-Dimethylformamide	15-30	50	10	Pink	Yellow	T	24
				0.5-15	100	10				
Ethyl benzene	C ₆ H ₅ C ₂ H ₅	122P	Toluene	110-2750µg/m ³	200	30	White	Pale brown	+	24
Ethylene oxide	C ₂ H ₄ O	163TPM	Ethylene oxide	1-50	50	10	Yellow	Reddish brown	+T	12*
		163TP	Ethylene oxide	0.1-5	50	10	Yellow	Pale orange	+T	12*
Formaldehyde	HCHO	91P	Formaldehyde	0.4-1.44	200	10	Yellow	Pink	T	12*
				0.02-0.4	200	30				
		91PL	Formaldehyde	0.20-0.80	200	10	Pale Yellow	Pink	T	12*
				0.01-0.20	200	30				
91TP	Formaldehyde	0.50-1.75	50	10	Yellow	Pale orange	T	12*		
		0.01-0.50	100	10						
Hexane	CH ₃ (CH ₂) ₄ CH ₃	102TP	Hexane	2-80	100	10	Yellowish brown	Greenish brown		36
Hydrogen cyanide	HCN	12TP	Hydrogen cyanide	4.5-9.0	50	10	Yellow	Pink		12
				0.3-4.5	100	10				
Hydrogen fluoride	HF	17TP	Hydrogen fluoride	3.0-9.0	50	10	Yellow	Brown	TH	30
				0.05-3.0	100	10				
Hydrogen sulphide	H ₂ S	4TP	Hydrogen sulphide	1.6-2.88	50	10	Yellow	Pink		24
		4S	Hydrogen sulphide	0.1-1.6 10-200ppb	150	5	Yellow	Purple	+T	18*
Isopropyl alcohol	CH ₃ CH(OH)CH ₃	113TP	Isopropyl alcohol	200-400	100	5	Pale vermilion	Pale blue	T	36
				20-200	100	10				
Methanol	CH ₃ OH	111TP	Methanol	20-300	50	10	Pale vermilion	Pale blue	T	24
Methyl ethyl ketone	CH ₃ COC ₂ H ₅	152TP	Methyl ethyl ketone	20-300	100	10	Yellow	Red	T	24*
Nitrogen dioxide	NO ₂	9P	Nitrogen dioxide	0.02-0.20	100	30	White	Orangish brown	T	30
Styrene	C ₆ H ₅ CH:CH ₂	124S	Styrene	0.2-4.0	200	5	White	Yellow	+	36
Tetrachloroethylene	Cl ₂ C:CCl ₂	133P	Tetrachloroethylene	300-720µg/m ³	100	15	Yellow	Purple	+T	24
				20-300µg/m ³	100	30				
		133TP	Tetrachloroethylene	40-84 2.5-40	50 100	10 10	Yellow	Reddish purple	+T	24
Toluene	C ₆ H ₅ CH ₃	122P	Toluene	2500-7000µg/m ³	200	10	White	Pale brown	+	24
				100-2500µg/m ³	200	30				
122TP	Toluene	2-80			100	10	White	Brown	+	36
					100	10				
Trichloroethylene	Cl ₂ C:CHCl	132P	Trichloroethylene	500-1200µg/m ³	100	15	Yellow	Purple	+T	24
				20-500µg/m ³	100	30				
		132TP	Trichloroethylene	15-33 1-15	50 100	10 10	Yellow	Reddish purple	+T	24
Vinyl chloride	CH ₂ :CHCl	131P	Vinyl chloride	50-1500µg/m ³	100	30	Yellow	Pale reddish purple	+T	24
		131TP	Vinyl chloride	3.0-9.6 0.2-3.0	50 100	10 10	Yellow	Reddish purple	T	36
Xylene	C ₆ H ₄ (CH ₃) ₂	123TP	Xylene	2-80	100	10	White	Brown	+	24
		122P	Toluene	540-13500µg/m ³	200	30	White	Pale brown	+	24

T: Temp Correction H: Humidity Correction +: Twin Tubes * Refrigerated Storage Mesh: Correction Factor
See page 44 for additional symbols and definitions.

■ Automatic Air Sampling Pump GSP-501FT

The Model GSP-501FT has been designed to be a small and compact air sampling pump available with an integrated flowmeter for Hand-held, Personal or site sampling. With this small size air sampling pump it is possible to carry on constant flow rate for 20 hours continuous sampling. This air sampling pump employs an extremely low noise air pump and has air pump automatic shut-off by preset timer or volume for integrated flow rate and accumulated time.

■ GSP-501FT Specification

Sampling mode	Timer Mode : Air pump automatically stops at set time Settable time: 1 minute to 30 hours Volume Mode : Air pump automatically stops at set volume Settable integrated volume: 0.010 to 900L
Settable instantaneous flow rate	Timer Mode : 50-500mL/min Volume Mode : 10-500mL/min (When set to 10-49 mL/min, the intermittent operation is performed at 50mL/min)
Constant flow rate operating range	10-49mL/min : 0.0-5.0kPa 50mL/min : 0.0-40.0kPa 100mL/min : 0.0-37.0kPa 200mL/min : 0.0-30.0kPa 300mL/min : 0.0-23.0kPa 400mL/min : 0.0-16.0kPa 500mL/min : 0.0-10.0kPa
Display	Liquid crystal digital display (with backlight), Display range : 0-600mL/min
Structure and function	Constant flow rate function (built-in set flow rate holding circuit), Autostart function (autostart after set standby time in standby mode), Diaphragm type air pump, Program Mode (5 sampling settings)
Accuracy of instantaneous flow measurement	Instantaneous flow rate: 50-500 mL/min \pm 5%
Accuracy of integrated flow measurement	[When set flow rate: 50 to 500mL/min] \pm 5%. <Volume Mode only> [When set flow rate: 10 to 49mL/min] \pm (2.5 \times sampling time [min]) mL.
Operating temperature range	0-40°C
Operating humidity range	10-90% RH (non-condensing)
Power supply	2 AA alkaline batteries (standard accessories, commercially available) 2 AA nickel-metal hydride batteries (commercially available)
Continuous operation time	2 AA alkaline batteries (Standard Accessories): 20 hours (Set flow rate: 200 mL/min, suction pressure: 2kPa or less, ambient temperature: 25°C)
Dimensions and weight	80(W) \times 40(D) \times 126(H) mm 280g (including batteries)
Standard accessories	2 AA alkaline batteries , detector tube adaptor, tube tip holder, dust filter (5 pcs), instruction manual, warranty certificate, inspection certificate
Directives and regulations	EU Directive:2014/30/EU(EMC), 2011/65/EU,(EU)2015/863(RoHS) UK Regulation :2016 No. 1091(EMC),2012 No.3032(RoHS)
EMC harmonised standards	EU:EN 61326-1:2013 UK:BS EN 61326-1:2013
RoHS designated standards	EU:EN IEC63000:2018 UK:BS EN IEC63000:2018

Intermittent Operation

When the instantaneous flow rate is set to 10 - 49mL/min in the Volume Mode, the intermittent operation is performed by sampling at an instantaneous flow rate of 50mL/min.

Example of Intermittent Operation

When the Volume Mode is selected and the flow rate is set to 10 mL/min and the set volume is 0.1L, after the sampling is started, the pump will pause for about 48 seconds after about 12 seconds of sampling at a flow rate of 50mL/min (samples until the sampled volume per minute reaches 10mL, then pauses).

Sampling at a flow rate of 50 mL/min for about 12 seconds and pausing for about 48 seconds are repeated until the set volume of 0.1 L is reached, taking about 10 minutes.

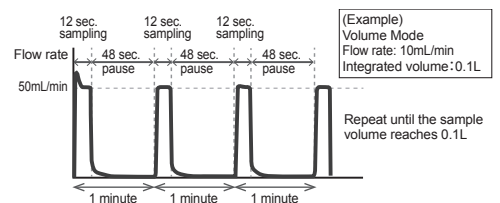

* If there is a sudden change in the gas concentration or if sampling is performed for a short period of time, the error of the sampling result may be large.

■ Measuring Procedure

- ① Break tips off the detector tube using the tube tip holder.



- ② Insert the detector tube to the inlet of the rubber tube holder. Put the power switch to ON. Adjust the flow rate, confirm that the timer of the air sampling pump is set, then push the start button.



- ③ After sampling, remove the detector tube from the rubber tube holder and read the concentration of the tube.

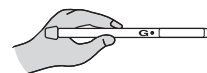

- * Please read carefully the instruction sheet of the detector tube to be used for timer and flow rate.

■ Sorbent tubes

Sorbent tubes are glass tubes filled with sorption agents such as activated charcoal or silica-gel, and are used to adsorb toxic gases in various environments.

Both ends of the tube are broken off and connected to a sampling pump for sample collection.

The adsorbate is then extracted using a solvent and analyzed using gas chromatography.

Product name/code		Layer	Filling quantity	Dimensions (mm)	Tubes/box	Shelf life (months)
Activated charcoal tube	251S-20	2	100/50	5.6 × 100	20	60
	251S2-20	1	150	5.6 × 100	20	60
Activated charcoal tube (Bead-shaped)	258-20	2	100/50	5.6 × 100	20	60
	258A-20	2	400/200	7.0 × 105	20	60
	258S2-20	1	150	5.6 × 100	20	60
Silica-gel tube	252S-20	2	400/200	7.0 × 105	20	60
	252S2-20	1	600	7.0 × 105	20	60
	252S3-20	2	150/75	5.6 × 100	20	60
	252S4-20	1	300	5.6 × 100	20	60

■ GASTEC NUMERICAL INDEX GAS DETECTOR TUBE LIST

Gastec Tube No.	Gas or Vapour to be Measured	Measuring Range (ppm)
1A	Carbon monoxide (Airtec tube)	5-50
1HH	Carbon monoxide	1-50%
1H		0.1-10%
1M		0.05-4%
1LM		25-2000
1L		2.5-2000
1La		8-1000
1LK		5-600
1LKC		5-100
1LL		5-50
1LC		1-30
1M	Gasoline (Petrol)	0.1-2%
1D	Carbon monoxide (Dosi tube)	1.04-2000
1DL		0.4-400
2A	Carbon dioxide (Airtec tube)	250-3000
2Ag		200-3000
2HT	Carbon dioxide (Injection tube)	10-100%
2HH	Carbon dioxide	2.5-40%
2H		0.5-20%
2L		0.13-6%
2LL		300-5000
2LC		100-4000
2D		Carbon dioxide (Dosi tube)
3H	Ammonia	0.2-32%
3HM		0.05-3.52%
3M		10-1000
3La		2.5-220
3L		0.5-78
3H	Dimethylamine	1.2-19.2%
3M	Trimethylamine	25-250
3S	Ammonia(for Automatic Air Sampling Pump)	0.5-5
3D	Ammonia (Dosi tube)	2.5-1000
3DL		0.1-10
3D	Dimethylamine (Dosi tube)	1.9-750
3D	Hydrazine (Dosi tube)	1.6-650
3D	N,N-Dimethylethylamine (Dosi tube)	4-1600
3D	Triethylamine (Dosi tube)	5.3-2100
3DL	Methylamine (Dosi tube)	0.19-19
3DL	Trimethylamine (Dosi tube)	0.23-23
4HT	Hydrogen sulphide	1-40%
4HP		0.25-20%
4HH		0.1-4%
4H		10-4000
4HM		25-1600
4M		12.5-500
4L		1-240
4LL		0.25-120
4LK		1-40
4LB		0.5-12
4LT	0.05-4.0	
4TP	Hydrogen sulphide (for Automatic Air Sampling Pump)	0.1-2.88
4S		10-200ppb
4D	Hydrogen sulphide (Dosi tube)	0.2-200
5H	Sulphur dioxide	0.05-8%
5M		20-3600
5L		1.25-200
5La		0.5-60
5LC		0.1-22
5Lb		0.05-10
5La	Thionyl chloride	1.44-21.6
5DH	Sulphur dioxide (Dosi tube)	10-600
5D		0.2-100
6AH	Water vapour (Airtec tube)	500-5000
6A		10-80mg/m ³
6Ag		150-3000mg/m ³
6	Water vapour	0.5-32mg/L
6L		0.05-2mg/L
6LP		3-100LB/MMCF

Gastec Tube No.	Gas or Vapour to be Measured	Measuring Range (ppm)
6LLP	Water vapour	2-10LB/MMCF
7H	Phosphine	200-5500
7J		2.5-1000
7		2.5-100
7L		0.15-5
7LA		0.05-9.8
8HH	Chlorine	0.25-10%
8H		25-1000
8La		0.1-16
8LL		0.025-2
8HH	Hydrogen chloride	1.5-30%
8H	Chlorine dioxide	45-450
8La	Bromine	0.05-0.8
8La	Chlorine dioxide	0.3-4.8
8TP	Chlorine (for Automatic Air Sampling Pump)	0.05-0.6
8D	Chlorine (Dosi tube)	0.08-100
9L	Nitrogen dioxide	0.5-125
9L	Iodine	0.2-12
9P	Nitrogen dioxide (for Automatic Air Sampling Pump)	0.02-0.20
9D	Nitrogen dioxide (Dosi tube)	0.1-30
9DL		0.01-3.0
10	NO & NO ₂ (Separate quantification)	2.5-200
11A	Nitrogen oxides (Airtec tube)	0.02-2
11HA	Nitrogen oxides (Total quantification)	50-2500
11S		5-625
11L		0.03-14
12H	Hydrogen cyanide	0.05-1.6%
12M		17-2400
12L		0.5-150
12LL		0.2-10
12L		Acetone cyanohydrin
12L	Boron trichloride	2.25-54
12TP	Hydrogen cyanide (for Automatic Air Sampling Pump)	0.3-9.0
12D	Hydrogen cyanide (Dosi tube)	1-200
13M	Carbon disulphide	15-5120
13		0.63-100
13L		0.1-8.1
13TP	Carbon disulphide (for Automatic Air Sampling Pump)	0.05-2.4
14R	Hydrogen chloride (for Low Humidity)	50-5000
14M	Hydrogen chloride	10-1000
14L		0.2-76
14D	Hydrogen chloride (Dosi tube)	1-100
14D	Hydrogen fluoride (Dosi tube)	2.5-250
14D	Nitric acid (Dosi tube)	0.8-80
15L	Nitric acid	0.1-40
15L	Hydrogen bromide	0.8-16
15L	Trichloroacetic acid	1-37
16	Phosgene	0.05-20
17	Hydrogen fluoride	0.25-100
17L		0.09-72
17LL		0.05-24
17	Fluorine	0.5-50
17TP	Hydrogen fluoride (for Automatic Air Sampling Pump)	0.05-9.0
17D	Hydrogen fluoride (Dosi tube)	1-100
17D	Hydrogen chloride (Dosi tube)	0.4-40
17D	Nitric acid (Dosi tube)	0.32-32
18M	Ozone	4-400
18L		0.025-6
19LA	Arsine	0.04-10
21	Carbonyl sulphide	5-200
21LA		2-125
22	Diborane	0.02-5
23M	Chlorine dioxide	0.1-10
23L		0.025-1.2
25	(NH ₃ ,SO ₂ ,H ₂ S,CO,NO ₂ ,)	Qualitative
26	(NH ₃ ,H ₂ S,CnHm)	Qualitative
27	(NH ₃ ,HCl,H ₂ S,NO ₂ ,SO ₂ ,CO,CO ₂)	Qualitative
28	HCl, COCl ₂ , SO ₂ , NO ₂ , H ₂ S, HCN, CO, CO ₂	Qualitative

Gastec Tube No.	Gas or Vapour to be Measured	Measuring Range (ppm)
30	Hydrogen	0.5-2%
31B	Oxygen	3-24%
32	Hydrogen peroxide	0.5-10
32D	Hydrogen peroxide (Dosi tube)	0.5-40
35	Sulphuric acid	0.5-5mg/m ³
40	Mercury vapour	0.05-13.2mg/m ³
45H	H ₂ S + SO ₂ (Total Quantification)	0.02-8.0%
45S	H ₂ S,SO ₂ (Separate Quantification)	SO ₂ : 0.25-20 H ₂ S: 1.25-120
51H	1,1,2-Trichloro-1,2,2-trifluoroethane (R113)	250-6000
51H	Chlorodifluoromethane (R22)	0.1-2.4%
51H	Dichlorodifluoromethane (R12)	325-7800
51H	1,2-Dichloro-1,1,2,2-tetrafluoroethane (R114)	475-11400
51H	Halothane	800-6400
51H	1,1,2,2-Tetrachloro-1,2-difluoroethane (R112)	125-3000
51H	Trichlorofluoromethane (R11)	275-6600
51H	1,1,1-Trichloro-2,2,2-trifluoroethane (R113a)	200-4800
51	1,1,2-Trichloro-1,2,2-trifluoroethane (R113)	10-400
51	1,1-Dichloro-1-fluoroethane (R141b)	10-1000
51	2,2-Dichloro-1,1,1-trifluoroethane (R123)	14-1600
51	Dichloropentafluoropropane (R225)	20-800
51	Chlorodifluoromethane (R22)	25-1000
51	Dichlorodifluoromethane (R12)	11-440
51	1,2-Dichloro-1,1,2,2-tetrafluoroethane (R114)	20-800
51	Enflurane	110-1230
51	Halothane	24-960
51	Methyl chloride	12-480
51	1,1,2,2-Tetrachloro-1,2-difluoroethane (R112)	7-280
51	Trichlorofluoromethane (R11)	8-320
51	1,1,1-Trichloro-2,2,2-trifluoroethane (R113a)	10-400
51	2-Chloro-1,1,1,2-tetrafluoroethane (R124)	45-1800
51L	1,1,2-Trichloro-1,2,2-trifluoroethane (R113)	1-54
51L	Chlorodifluoromethane (R22)	2.5-135
51L	Dichlorodifluoromethane (R12)	1.8-97.2
51L	1,1-Dichloro-1-fluoroethane (R141b)	1.1-22
51L	1,2-Dichloro-1,1,2,2-tetrafluoroethane (R114)	1.8-97.2
51L	2,2-Dichloro-1,1,1-trifluoroethane (R123)	1.4-28
51L	Dichloropentafluoropropane (R225)	1.4-28
51L	Enflurane	25-145
51L	Halotane	3-60
51L	Methyl chloride	1.6-86.4
51L	Methylene chloride	1-54
51L	1,1,2,2-Tetrachloro-1,2-difluoroethane (R112)	1-54
51L	Trichlorofluoromethane (R11)	0.8-43.2
51L	1,1,1-Trichloro-2,2,2-trifluoroethane (R113a)	0.8-43.2
52	1-Nitropropane	4.2-252
52	2-Nitropropane	3.7-222
52	Acetonitrile	3-180
52	Nitrogen dioxide	0.5-30
52	Nitroethane	4-240
52	Nitromethane	5-300
53	Dimethyl sulphide	0.15-10
53	Dimethyl disulphide	0.3-6
60	Phenol	0.12-183
60	Napthalene	0.5-14
61	o-Cresol	0.35-67.5
61	m-Cresol	1-25
61	p-Cresol	1-25
70	Mercaptans	0.5-120
70L		0.1-8
70	Ethyl mercaptan	0.5-120
70	Isopropyl mercaptan	10-240
70	Methyl mercaptan	0.35-84
70	Propyl mercaptan	22.5-540
70L	Butyl mercaptan	0.16-12.8
70L	tert-Butyl mercaptan	0.1-8
70L	Ethyl mercaptan	0.1-8
70L	Methyl mercaptan	0.1-8

Gastec Tube No.	Gas or Vapour to be Measured	Measuring Range (ppm)
70L	Propyl mercaptan	0.12-9.6
70LN	Mercaptans	0.1-8
70LN	Methyl mercaptan	0.1-8
70LN	Ethyl mercaptan	0.13-10.4
70LN	tert-Butyl mercaptan	1-40
70LN	1-Propanethiol (Propyl mercaptan)	1-25
71H	Methyl mercaptan	20-2700
71		0.25-140
71H	Ethyl mercaptan	100-3800
72	Ethyl mercaptan	0.5-120
72L		0.2-75
72LN		0.15-57.5
75	tert-Butyl mercaptan	2.5-150mg/m ³
75N		1.25-250mg/m ³
75L		0.5-30mg/m ³
75L	2-Mercaptoethanol	0.5-7.5
75LN	tert-Butyl mercaptan	0.5-39mg/m ³
76H	Tetrahydrothiophene	10-200
76M		10-100mg/m ³
76		1-10
77	TBM,DMS	1-15mg/m ³
80	Acid gases	1-80
80	Chlorine	0.7-14
80	Hydrogen chloride	8-160
80	Iodine	0.12-2.4
80	Nitric acid	5-100
80	Nitrogen dioxide	0.2-4
80	Sulphur dioxide	1.5-30
81	Acetic acid	1-100
81L		0.125-23.0
81	Acetic anhydride	0.6-15
81	Acrylic acid	2-50
81	Formic acid	5.2-130
81	Isovaleric acid	2-50
81	Maleic anhydride	0.8-20
81	Methacrylic acid	1.8-45
81	Propionic acid	3-75
81L	Acetic anhydride	0.15-6
81L	Acrylic acid	0.45-18
81L	Butyric acid	0.325-13
81L	Formic acid	0.5-20
81L	Isovaleric acid	0.38-15
81L	Methacrylic acid	0.35-14
81L	Propionic acid	0.25-10
81L	Valeric acid	0.38-15
81D	Acetic acid (Dosi tube)	0.5-100
81D	Acetic anhydride (Dosi tube)	0.3-60
81D	Formic acid (Dosi tube)	0.55-110
91M	Formaldehyde	8-6400
91		2-100
91L		0.1-45.0
91LL		0.05-1
91L	Benzaldehyde	4-92
91L	Cyclohexanone	10-470
91L	Diisobutyl ketone	0.58-29
91L	Metaldehyde	0.065-3.25
91L	Propionaldehyde	0.76-38
91P	Formaldehyde (for Automatic Air Sampling Pump)	0.02-1.44
91PL		0.01-0.80
91TP		0.01-1.75
91D	Formaldehyde (Dosi tube)	0.1-20
91D	Acetaldehyde (Dosi tube)	0.1-20
91D	Furfural (Dosi tube)	0.3-60
91D	Methyl ethyl ketone (Dosi tube)	0.125-25
92	Acetaldehyde	5-750
92M		2.5-100
92L		1-20
92	Diacetyl	25-1500

Gastec Tube No.	Gas or Vapour to be Measured	Measuring Range (ppm)
93	Acrolein	3.3-800
100A	LPG (Liquified petroleum gas)	0.02-0.8%
100A	Propylene	0.02-0.8%
100A	Xylene	0.1-1.2%
100B	Propane (Injection tube)	0.1-2%
101	Gasoline (Petrol)	0.015-1.2%
101L		30-2000
101	Heptane	0.015-1.2%
101	Isooctane	0.027-0.54%
101	Octane	0.036-0.72%
101L	Allyl chloride	0.1-3.4%
101L	Heptane	30-2000
101L	Isobutene	0.07-2.2%
102H	Hexane	0.015-1.2%
102L	Hexane	3.5-1200
102H	Cyclohexane	0.015-1.2%
102H	Methylcyclohexane	0.04-0.84%
102L	Acrylonitrile	600-14400
102L	Chlorocyclohexane	50-1200
102L	Cyclohexane	60-1440
102L	Diisobutyl ketone	0.2-1%
102L	tert-Butyl alcohol	500-12000
102TP	Hexane (for Automatic Air Sampling Pump)	2-80
103	Hydrocarbons (Lower class)	0.05-2.4%
103	Acetylene	0.075-3.6%
103	Butane	0.035-1.68%
103	Ethylene	0.35-16.8%
103	Heptane	0.035-1.68%
103	Isobutane	0.035-1.68%
103	Isopentane	0.045-2.16%
103	Hexane	0.025-1.2%
103	Pentane	0.0375-1.8%
103	Propane	0.05-2.4%
104	Butane	25-1400
104	Isobutane	55-3080
104	Pentane	30-1680
105	Hydrocarbons (Higher class)	100-3000
105	Heptane	90-2700
105	Hexane	80-2400
105	Nonane	130-3900
105	Octane	100-3000
105	Decane	200-6000
106	Petroleum naphtha	0.5-28mg/L
106	Petroleum benzine	0.5-28mg/L
106	Petroleum ether	0.5-28mg/L
107	Unknown Gases	Qualitative
108	Kerosene, Gasoline	Qualitative
109AD	Oil mist (Airtec tube)	0.1-5mg/m ³
109A		0.3-1.5mg/m ³
111	Methanol	0.002-6.0%
111L		20-1000
111LL		2-62
111L	Ethylene chlorohydrin	80-200
111TP	Methanol (for Automatic Air Sampling Pump)	20-300
112	Ethanol	0.01-7.5%
112L		50-2000
112D	Ethanol (Dosi tube)	100-25000
113	Isopropyl alcohol	0.02-5.0%
113L		20-800
113LL		20-460
113	Propyl alcohol	0.04-2.5%
113L	Divinyl methoxysilane	6.5-25.0
113L	Ethylene glycol monobutyl ether	200-1000
113L	Ethylene glycol monoethyl ether	110-1000
113L	Ethylene glycol monomethyl ether	75-760
113L	Ethylene glycol monomethyl ether acetate	300-1300
113L	Propyl alcohol	130-560
113L	Vinyl trimethoxysilane	6.5-25.0

Gastec Tube No.	Gas or Vapour to be Measured	Measuring Range (ppm)
113LL	Ethylene glycol monobutyl ether	60-400
113LL	Ethylene glycol monoethyl ether	46-460
113LL	Ethylene glycol monomethyl ether	44-440
113LL	1-Methoxy-2-propanol	26-260
113LL	Propyl alcohol	55-170
113TP	Isopropyl alcohol (for Automatic Air Sampling Pump)	20-400
114	1-Butanol	10-150
114	1,2-Dimethoxyethane	100-1030
115	2-Butanol	5-150
116	Isobutyl alcohol	3.7-150
117	Isoamyl alcohol	5-300
118	Cyclohexanol	5-100
119	Methylcyclohexanol	5-100
120	Aromatic hydrocarbons	0.4-200
121S	Benzene	2-312
121		2.5-120
121SL		1-100
121L		0.1-65
121SP		0.2-66
121	Diisobutylene	45-540
121	α -Pinene	95-1140
121L	Methylene iodide	0.22-22
121L	Methyl iodide	0.32-32
121P	Benzene (for Automatic Air Sampling Pump)	250-3000 μ g/m ³
121TP		0.1-14.5
122	Toluene	5-690
122L		1-100
122	Ethyl benzene	11-330
122L	Cumene	2-100
122L	Diethyl benzene	2-150
122L	Ethyl benzene	1-70
122L	Xylene	2-200
122P	Toluene (for Automatic Air Sampling Pump)	100-7000 μ g/m ³
122TP		2-80
122P	Ethyl benzene (for Automatic Air Sampling Pump)	110-2750 μ g/m ³
122P	Xylene (for Automatic Air Sampling Pump)	540-13500 μ g/m ³
122DL	Toluene (Dosi tube)	2-500
122DL	Benzene (Dosi tube)	2.4-600
122DL	Cumene (Dosi tube)	3.4-850
122DL	Ethyl benzene (Dosi tube)	2.8-700
122DL	Xylene (Dosi tube)	3.4-850
122DL	Styrene (Dosi tube)	26-6500
123	Xylene	5-625
123L		2-200
123	Trimethyl benzene	10-300
123TP	Xylene (for Automatic Air Sampling Pump)	2-80
124	Styrene	10-1500
124L		2-100
124L	Divinyl benzene	1-15
124S	Styrene (for Automatic Air Sampling Pump)	0.2-4
126	Chlorobenzene	2-500
126L		0.5-57
127	o-Dichlorobenzene	2.5-300
127	m-Dichlorobenzene	2.5-300
127	p-Dichlorobenzene	2.5-300
127P	p-Dichlorobenzene (for Automatic Air Sampling Pump)	100-3000 μ g/m ³
128	Stoddard solvent	50-8000mg/m ³
130L	Vinylidene chloride	0.4-40.6
131	Vinyl chloride	0.025-2%
131La		0.25-54
131L		0.1-6.9
131LB		0.4-70
131L	1,1,2,2-Tetrachloroethane	2-30
131L	Allyl chloride	3.2-48
131La	1,3-Dichloropropene	0.5-10
131La	1,2,4-Trichlorobenzene	0.65-13
131La	2-Methyl allyl chloride	2.8-55
131La	Ethyl chloroformate	7-140

Gastec Tube No.	Gas or Vapour to be Measured	Measuring Range (ppm)
131La	Methyl chloroformate	58-1160
131La	p-Ethyl benzylchloride	2.5-50
131La	Propylene dichloride	40-800
131P	Vinyl chloride(for Automatic Air Sampling Pump)	50-1500µg/m ³
131TP		0.2-9.6
132HH	Trichloroethylene	0.05-2.5%
132HA		20-1300
132M		2-270
132L		0.8-90
132LL		0.125-8.8
132HH	Tetrachloroethylene	0.075-1.5%
132HA	1,2-Dichloroethylene	80-800
132HA	1,3-Dichloropropene	45-450
132L	Benzyl chloride	1.6-20
132LL	1,2-Dichloroethylene	0.375-6
132LL	Dichlorvos	0.11-1.8
132P	Trichloroethylene (for Automatic Air Sampling Pump)	20-1200µg/m ³
132TP		1-33
132D	Trichloroethylene (Dosi tube)	3-300
132D	Chlorine (Dosi tube)	2.4-240
132D	1,2-Dichloroethylene (Dosi tube)	6-600
132D	Hydrogen chloride (Dosi tube)	1.8-180
132D	Tetrachloroethylene (Dosi tube)	1.5-150
133HA	Tetrachloroethylene	7-900
133M		2-220
133L		1-75
133LL		0.1-6.6
133L	Pentachloroethane	40-500
133P	Tetrachloroethylene (for Automatic Air Sampling Pump)	20-720µg/m ³
133TP		2.5-84
133D	Tetrachloroethylene (Dosi tube)	3-150
134	Carbon tetrachloride	0.5-60
134L		0.25-11
134	Chloropicrin	2.5-60
134L	Chloropicrin	0.28-5.5
135	1,1,1-Trichloroethane(Methyl chloroform)	100-2000
135L		6-900
135	1,1,2-Trichloroethane	220-750
135	1,1-Dichloroethane	90-450
135	Chlorobromomethane	22-110
135	Ethylene dichloride (1,2-Dichloroethane)	400-2000
135L	1,1,2,2-Tetrabromoethane	0.92-9.2
135L	1,2,3-Trichloropropane	36-360
135L	Ethylene dichloride (1,2-Dichloroethane)	104-1040
136H	Methyl bromide	10-600
136L		2.5-200
136LA		1-36
136LL		0.1-3.0
136H	n-Butyl bromide	24-360
136H	Chloro bromomethane	18-270
136H	Ethylene dibromide (1,2-Dibromoethane)	14-210
136L	1,1-Dibromoethane	7-70
136L	Benzyl bromide	11-100
136L	Bromoform	1-50
136L	n-Butyl bromide	10-100
136L	Chlorobromomethane	11-110
136L	Dibromomethane	5-50
136L	Ethyl bromide	2.5-200
136L	Ethylene dibromide (1,2-Dibromoethane)	8-80
136LA	n-Butyl bromide	1-43.2
136LA	n-Propyl bromide	1-18
136LA	Chloro bromomethane	0.7-12.6
137	Chloroform	4-400
137LA		0.5-30
137LL		0.3-4.5
138	Methylene chloride	30-500
138L		4-150
138	Ethyl chloride	15-150

Gastec Tube No.	Gas or Vapour to be Measured	Measuring Range (ppm)
139	1,2-Dichloroethylene	5-250
140	Aliphatic hydrocarbons	6-3000
141	Ethyl acetate	0.1-1.5%
141L		20-800
141	Vinyl acetate	0.06-0.9%
141L	2-Hexyl alcohol	168-1680
141L	Cymene	2.4-96
141L	Diisopropyl benzene	16-108
141L	Ethyl acrylate	8.4-336
141L	Isopropyl ether	17.6-704
141L	Mesityl oxide	72-1080
141L	Methyl acrylate	7.2-288
141L	Methyl isothiocyanate	5.4-216
142	Butyl acetate	0.05-0.8%
142L	Butyl acetate	10-300
142L	Butyl acrylate	7-210
142L	Diethyl ketone	5-513
142L	Isobutyl acrylate	5.5-165
143	Vinyl acetate	5-250
144	Isobutyl acetate	10-300
145	Propyl acetate	20-500
146	Isopropyl acetate	10-500
147	Amyl acetate	10-200
148	Isoamyl acetate	10-200
149	Methyl methacrylate	10-500
149	Allyl isothiocyanate	4.4-88
151	Acetone	0.05-2.0%
151L		50-12000
151	Cyclohexene	0.05-0.8%
151L	Methyl ethyl ketone	21-1680
151L	Propionaldehyde	24-1880
151TP	Acetone (for Automatic Air Sampling Pump)	25-800
151D	Acetone (Dosi tube)	5-1500
151D	Acetaldehyde (Dosi tube)	4-1200
151D	Methyl ethyl ketone (Dosi tube)	6.5-1950
151D	Methyl isobutyl ketone (Dosi tube)	11.5-3450
152	Methyl ethyl ketone	0.02-0.6%
152L		10-384
152TP	Methyl ethyl ketone (for Automatic Air Sampling Pump)	20-300
152D	Methyl ethyl ketone (Dosi tube)	2-600
152D	Acetaldehyde (Dosi tube)	1.2-360
152D	Acetone (Dosi tube)	1.4-420
152D	Methyl isobutyl ketone (Dosi tube)	4-1200
153	Methyl isobutyl ketone	0.05-0.6%
153L		2.5-130
153	Styrene	0.15-2.3%
154	Cyclohexanone	2-72
154	Diacetone alcohol	2-100
154	Furfural	2-30
154	Isophorone	2-30
155	Methylcyclohexanone	2-80
159	Tetrahydrofuran	25-800
159L		5-232
159	1,4-Dioxane	25-144
161	Ethyl ether	0.04-1.0%
161L		10-1120
161	Isopropyl ether	0.018-0.45%
161	Methyl ether	0.034-0.85%
161	Tetrahydrofuran	0.056-1.4%
161	Toluene	0.02-0.8%
163	Ethylene oxide	0.05-3.0%
163L		0.4-550
163LL		0.1-10
163	1,4-Dioxane	0.1-6.0%
163	Propylene oxide	0.065-3.9%
163L	Epichlorohydrin	1.2-120
163L	Propylene oxide	1-100
163TPM	Ethylene oxide (for Automatic Air Sampling Pump)	1-50

Gastec Tube No.	Gas or Vapour to be Measured	Measuring Range (ppm)
163TP	Ethylene oxide (for Automatic Air Sampling Pump)	0.1-5
165L	Ethylene glycol	10-100mg/m ³
166	Methyl tert-butyl ether	10-660
166	Methyl isothiocyanate	39.8-1766
171	Acetylene	0.05-4.0%
171	Benzene	0.03-0.6%
171	Ethylene	0.1-2.0%
171	1,1,1-Trichloroethane	0.06-1.2%
172	Ethylene	25-1680
172L		0.2-100
172	Acetylene	32.5-1040
174	1,3-Butadiene	50-800
174L		2.5-100
174LL		0.5-5
174	1,3-Pentadiene	250-4000
174L	1,3-Pentadiene	42.5-850
174D	1,3-Butadiene (Dosi tube)	1.3-200
174D	Ethylene (Dosi tube)	1.5-240
174D	Isoprene (Dosi tube)	2.5-400
174D	trans-1,2-Dichloroethylene (Dosi tube)	3.8-600
174D	Vinyl chloride (Dosi tube)	1.5-240
180	Amines	5-100
180L		0.5-10
180	Allyl amine	8.5-170
180	Ammonia	1.5-30
180	Butylamine	8-160
180	tert-Butylamine	5.5-110
180	Di-n-Butylamine	5-100
180	Cyclohexylamine	7-140
180	Diethylamine	5.5-110
180	Diethylethanolamine	6-120
180	Diisopropylamine	5-100
180	Dimethyl ethanolamine	6.5-130
180	Dimethylamine	5.5-110
180	Dimethylaminopropylamine	8-160
180	Dipropylamine	4-80
180	N,N-Dimethylethylamine	4-80
180	N-Ethyl morpholine	5-100
180	Ethylamine	5-100
180	Ethylenediamine	14-280
180	Hexylamine	9-180
180	Isopropyl amine	5.5-110
180	Methylamine	5-100
180	N-Methyl morpholine	5-100
180	N-Methyl pyrrolidone	13.5-270
180	Monoethanolamine (Ethanolamine)	7-140
180	Morpholine	9-180
180	Propylamine	6-120
180	Propylene imine	5.5-110
180	Tetramethylenediamine	8.5-170
180	Triethylamine	4.5-90
180	Trimethylamine	3.5-70
180L	Allyl amine	0.4-8
180L	Butylamine	0.55-11
180L	Cyclohexylamine	0.5-10
180L	Di-n-butylamine	0.4-8
180L	Diethylamine	0.45-9
180L	Diethylaminoethanol	0.6-12
180L	Diethylenetriamine	0.95-19
180L	Diisopropylamine	0.3-6
180L	Dimethylamine	0.45-9
180L	2-Dimethylaminoethanol	0.65-13
180L	Dimethylaminopropylamine	0.6-12
180L	N,N-Dimethylethylamine	0.3-6
180L	Dipropylamine	0.35-7
180L	Ethanolamine	1.95-39
180L	Ethylamine	0.45-9
180L	Ethylenediamine	0.9-18

Gastec Tube No.	Gas or Vapour to be Measured	Measuring Range (ppm)
180L	N-Ethyl morpholine	0.3-6
180L	Hexamethylenediamine	1.55-31
180L	Hexylamine	0.65-13
180L	Isopropylamine	0.45-9
180L	Methylamine	0.5-10
180L	Morpholine	0.5-10
180L	N-Methyl morpholine	0.3-6
180L	Pentamethylenediamine	0.75-15
180L	Propylamine	0.5-10
180L	Propylene imine	0.35-7
180L	Tetramethylenediamine	0.8-16
180L	Triethylamine	0.3-6
180L	Trimethylamine	0.25-5
181	Aniline	1.25-60
181	N,N-Dimethylaniline	2.5-30
181	N-Methyl aniline	3.5-42
181	o-Toluidine	5-60
182	Pyridine	0.2-36.4
182	4-Methyl pyridine	0.38-10.5
183	N,N-Dimethyl formamide	0.8-90
183TP	N,N-Dimethylformamide(for Automatic Air Sampling Pump)	0.5-30
183TP	N,N-Dimethylacetamide(for Automatic Air Sampling Pump)	3.0-57.5
184	N,N-Dimethyl acetamide	1.5-240
185	Hydrazine	0.04-2
185	Dimethylhydrazine	0.1-2
185	Methyl hydrazine	0.6-12
191	Acrylonitrile	2-360
191L		0.1-18
191	Propionitrile	50-1200
191L	2-Methyl-3-butenitrile	0.4-12
191L	2-Pentenenitrile	0.24-7.2
191L	3-Pentenenitrile	0.4-12
191L	Butyronitrile	6-180
191TP	Acrylonitrile(for Automatic Air Sampling Pump)	0.2-12.6
192	Methacrylonitrile	0.2-32
193	2-Pentenenitrile	0.5-15
211H	Sulphide ion in solution	10-1000
211M		2-300
211		1-100
211LL		0.5-20
218	Ozone in solution	1-10mg/L
221L	Chloride ion in solution	25-1000mg/L
221LL		10-200mg/L
221L	Bromide ion in solution	55-2200mg/L
221LL	Bromide ion in solution	24-480mg/L
222	Free residual chlorine	0.1-10mg/L
230H	Methyl iodide	100-34800
230		0.5-108
231	Sulphuryl fluoride	1-20
232	1,2-Dichloroethane	1-39
233	Chloropicrin	0.045-22
234L	Methyl isothiocyanate	0.07-25
271	Mercury in solution	1-20mg/L
273	Chromium(VI) in solution	0.5-50mg/L
281	Iron in solution	5-50mg/L
284	Copper in solution	1-20mg/L
285	Zinc in solution	3-20mg/L
291	Nickel in solution	5-50mg/L

■ About operating environment

Most tubes can be used in the temperature range of 0 - 40°C and relative humidity range of 0 - 90%. However a few tubes have a different temperature range or humidity range. Please refer to the instruction manuals for use.

■ Storage and disposal of Gastec detector tubes

As detector tubes contain sensitive reagents that are ready to react, and some reagents might be corrosive, care should be taken for their storage and disposal.

● Storage of detector tubes

Detector Tubes must be stored in the specified storage condition. Two storage conditions are specified depending on the detector tube; in a cool and dark place (15 to 25°C(59 to 77°F)) or in a refrigerator (0 to 10°C(32 to 50°F)). But it is preferably recommended to store all detector tubes in a refrigerator. Do not expose them to direct sunlight. Keep them in a safe place and out of reach of children.

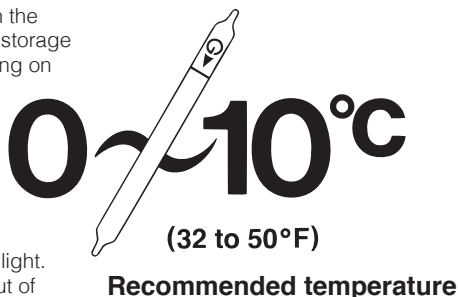

● Disposal of detector tubes

Used or date-expired detector tubes should be disposed properly in accordance with your local regulations. For further information, consult your Gastec representative.

■ Units of concentrations

% (Per cent)

Ratio of the volume of a substance to the volume of its medium expressed in percentage:

$$= \frac{\text{Volume of substance}}{\text{Volume of medium}} \times 100$$

ppm (parts per million)

Ratio of the volume of a substance to the volume of its medium expressed in parts per million:

$$= \frac{\text{Volume of substance}}{\text{Volume of medium}} \times 10^6$$

ppb (parts per billion)

Ratio of the volume of a substance to the volume of its medium expressed in parts per billion:

$$= \frac{\text{Volume of substance}}{\text{Volume of medium}} \times 10^9$$

mg/m³ (milligrams per cubic metre)

Ratio of the weight of a substance expressed in mg to the volume of its medium of 1 m³ (1,000L). This unit is mainly used for concentrations of particulate substances, but can also be applied to gases and vapours.

mg/L (milligrams per litre)

Ratio of the weight of a substance expressed in mg to the volume of its medium of 1L. This unit is mainly used for concentrations of particulate substances. but can also be applied to gases and vapours.

LB/MMCF (pounds per million cubic feet)

Ratio of the weight of a substance expressed in LB to the volume of its medium of 1,000,000 cubic feet.
1mg/L = 1000mg/m³ = 1358ppm = 62.3LB/MMCF (25°C, 1013hPa)

● Relations between concentration units

ppm = % × 10,000

% = ppm × 0.0001

ppb = % × 10,000,000

% = ppb × 0.000001

$$\text{mg/m}^3 = \text{ppm} \times \frac{M}{22.4} \times \frac{273}{(273+t)} \times \frac{P}{1013}$$

$$\text{ppm} = \text{mg/m}^3 \times \frac{22.4}{M} \times \frac{(273+t)}{273} \times \frac{1013}{P}$$

$$\% = \text{mg/L} \times \frac{22.4}{M} \times \frac{(273+t)}{273} \times \frac{1}{10}$$

$$\text{mg/L} = \% \times \frac{M}{22.4} \times \frac{273}{(273+t)} \times 10$$

Where :

M: Molecular weight

22.4 (L) : Volume of 1 mol at 0°C (32°F) under 1 atmospheric pressure

273 (K) : K represents an absolute temperature.

$$0^\circ\text{C} \doteq 273\text{K}, t^\circ\text{C} = (273 + t)\text{K}$$

1013 (hPa) : 1 atmospheric pressure in hectopascal

P : Atmospheric pressure at the time of measurement in hectopascal

Quantity of tubes per box: 10 tubes each

Tube No. & Name:

Gastec Detector Tube to be used.

Measuring Range:

Measuring ranges can be obtained by multiple or half pump strokes taken.

TLV:

Threshold Limit Value (TLV) for 2022 adopted by American Conference of Governmental Industrial Hygienists (ACGIH).

TLV-TWA:

Threshold Limit Value-Time Weighted Average -the time-weighted average concentration for a normal 8-hour workday and a 40-hour workweek, to which nearly all workers may be repeatedly exposed, day after day, without adverse effect.

TLV-C:

The concentration that should not be exceeded during any part of the working exposure.

Note:

- T Tubes need a temperature correction factor or table for the true concentration.
- H Tubes need a humidity correction factor or table for the true concentration.
- + Five tests (tubes) per box. Twin tubes to be combined with primary and analyzer tubes.
- ++ Nine tests (tubes) per box.
- P Use Pyrotec pyrolyzer No. 840 and GASTEC gas sampling pump.
- M Tube 121SP Benzene tube in the mixture of other Hydrocarbons.
- ⊕ Five tests (tubes) and long size glass detector tube for tube 31B only.

Shelf Life (year):

Actual shelf life (the term of validity) is printed on the tube box in final inspection process.

Refrigerated Storage:

* Tubes to be stored at 10°C (50°F) or below.

No. of Pump Strokes:

Number in circle means standard pump strokes. One ① stroke of the sampling pump draws a 100mL air sample. One half ①/2 pump strokes draw a 50mL air sample.

Correction factor/chart:

Mesh means a correction factor or chart for the true concentration which is enclosed with each box of detector tubes.

Detector tubes are primarily designed to measure specific gases. But it is also possible to measure other substances of similar chemical properties with the aid of a correction factor or chart. A correction factor is a figure which is multiplied by the concentration interpreted from the colour starting on the detector tube. The correction may also be presented as a chart on tube if the correction relationship is nonlinear. Therefore, please make use of the correction factor/chart measuring ranges as a reference. Moreover, this factor may vary slightly between production batches. For a more precise factor please contact your Gastec distributor.

Tube 72P

Tube No.72P works directly off regulated residential LP gas line pressure.

Warning

1. Use only Gastec detector tubes with a Gastec Pump.
2. Do not interchange or use non-Gastec parts or components in Gastec's detector tube and pump system.
3. The use of non-Gastec parts or components in Gastec's detector tube and pump system or use of a non-Gastec detector tube with a Gastec pump or use of a Gastec detector tube with a non-Gastec pump may result in property damage, serious bodily injury, and death; voids all warranties; and voids all performance and data accuracy guaranties.

Changes on the Tube List

Changes from 25th edition as of August 2019 to 25th edition as of April 2023

Page in 25th edition	Changes
Page 3	<ul style="list-style-type: none"> • The shelf life of Acetaldehyde 92 was changed (2years → 36months). • The stain colour term of Acetaldehyde 92L was changed (Brown → Reddish brown). • The Measuring range of Acetic acid 81L was changes (10-25.0 → 10-23.0). • The shelf life of Acetylene 103 (Hydrocarbons (Lower class)) was changed (2years → 30months). • The shelf life of Allyl amine 180L(Amines) was changed (2years → 36months). • The Measuring range of Allyl isothiocyanate 149(Methyl methacrylate) was changes (5-200 → 4.4-88).
Page 4	<ul style="list-style-type: none"> • The shelf life of Allyl chloride 131L(Vinyl chloride) was changed (2years → 30months). • The shelf life of Amines 180L was changed (2years → 36months). • The Measuring range of Ammonia 3La was changes (100-200 → 100-220). • The shelf life of Arsine 19LA was changed (2years → 27months). • The Measuring range of Benzyl bromide 136L(Methyl bromide) was changed (10-100 → 11-100). • The shelf life of Benzyl bromide 136L(Methyl bromide) was changed (2years → 27months).
Page 5	<ul style="list-style-type: none"> • The shelf life of Benzyl chloride 132L(Trichloroethylene) was changed (2years → 30months). • The shelf life of Bromoform 136L(Methyl bromide) was changed (2years → 27months). • The shelf life of Butane 103 (Hydrocarbons (Lower class)) was changed (2years → 30months). • The stain colour term of Butyl acetate 142L was changed (Blackish brown → Blackish brown (Pale blue after few minutes)). • The stain colour term of Butyl acrylate 142L(Butyl acetate) was changed (Blackish brown → Blackish brown (Pale blue after few minutes)). • The shelf life of Butylamine 180L(Amines) was changed (2years → 36months). • The shelf life of n-Butyl bromide 136L(Methyl bromide) was changed (2years → 27months). • The shelf life of n-Butyl bromide 136LA(Methyl bromide) was changed (2years → 36months). • The shelf life of tert-Butyl mercaptan 75 was changed (2years → 36months).
Page 6	<ul style="list-style-type: none"> • The Measuring range of Carbon disulphide 13M was changed (20-50 → 15-50, 1600-4000 → 1600-5120). • The shelf life of Carbon disulphide 13L was changed (2years → 36months).
Page 7	<ul style="list-style-type: none"> • The shelf life of Carbonyl sulphide 21 was changed (2years → 30months). • The shelf life of Carbonyl sulphide 21LA was changed (2years → 36months). • The Measuring range of Chlorobenzene 126L was changes (10-43 → 10-57). • The shelf life of Chlorobromomethane 136L(Methyl bromide) was changed (2years → 27months). • The shelf life of Chlorobromomethane 136LA(Methyl bromide) was changed (2years → 36months).
Page 8	<ul style="list-style-type: none"> • The Measuring range of o-Cresol 61 was changes (0.4-1 → 0.35-1, 25-62.5 → 25-67.5). • The Measuring range of Cyclohexanone 154 was changes (30-75 → 30-72). • The shelf life of Cyclohexylamine 180L(Amines) was changed (2years → 36months).
Page 9	<ul style="list-style-type: none"> • The Measuring range of Diacetone alcohol 154(Cyclohexanone) was changes (2.5-100 → 2-100). • The shelf life of Diacetyl 92(Acetaldehyde) was changed (2years → 36months). • The shelf life of 1,1-Dibromoethane 136L(Methyl bromide) was changed (2years → 27months). • The shelf life of Dibromomethane136L(Methyl bromide) was changed (2years → 27months). • The shelf life of Di-n-butylamine 180L(Amines) was changed (2years → 36months). • The shelf life of 1,2-Dichloroethylene 139 was changed (2years → 30months).
Page 10	<ul style="list-style-type: none"> • The shelf life of Diethylamine 180L(Amines) was changed (2years → 36months). • The shelf life of Diethylaminoethanol 180L(Amines) was changed (2years → 36months). • The shelf life of Diethylenetriamine 180L(Amines) was changed (2years → 36months). • No.142L was added to Diethyl ketone. • The shelf life of Diisopropylamine 180L(Amines) was changed (2years → 36months). • The Measuring range of Diisopropyl benzene 141L(Ethyl acetate) was changes (16.5-108 → 16-108). • No.114 was added to 1,2-Dimethoxyethane. • The shelf life of Dimethylamine 180L(Amines) was changed (2years → 36months). • The shelf life of 2-Dimethylaminoethanol 180L(Amines) was changed (2years → 36months). • The shelf life of Dimethylaminopropylamine 180L(Amines) was changed (2years → 36months). • The shelf life of N,N-Dimethylethylamine 180L(Amines) was changed (2years → 36months).
Page 11	<ul style="list-style-type: none"> • The Note of Dimethylhydrazine 185(Hydrazine) was changed (H → TH). • The Measuring range of 1,4-Dioxane 159(Tetrahydrofuran) was changes (25-140 → 25-144). • The shelf life of Dipropylamine 180L(Amines) was changed (2years → 36months). • The Measuring range of Enflurane 51(Fluorochlorocarbons) was changes (100-1230 → 110-1230). • The shelf life of Ethanolamine 180L(Amines) was changed (2years → 36months). • The shelf life of Ethylamine 180L(Amines) was changed (2years → 36months). • The shelf life of Ethyl bromide 136L(Methyl bromide) was changed (2years → 27months).

Page 12	<ul style="list-style-type: none"> • The shelf life of Ethylene 103 (Hydrocarbons (Lower class)) was changed (2years → 30months). • The shelf life of Ethylenediamine 180L(Amines) was changed (2years → 36months). • The shelf life of Ethylene dibromide 136L(Methyl bromide) was changed (2years → 27months). • The shelf life of Ethylene dichloride 135L(1,1,1-Trichloroethane) was changed (2years → 27months). • The Measuring range of Ethylene oxide 163L was changes (100-350 → 100-550). • The Measuring range of Ethyl ether 161L was changes (400-1200 → 400-1120).
Page 13	<ul style="list-style-type: none"> • The shelf life of N-Ethyl morpholine 180L(Amines) was changed (2years → 36months). • The Measuring range of Formaldehyde 91L was changed (5.0-40 → 5.0-45.0). • The Measuring range of Halothane 51(Fluorochlorocarbons) was changes (240-960 → 24-960). • The shelf life of Heptane 103(Hydrocarbons (Lower class)) was changed (2years → 30months). • The shelf life of Hexamethylenediamine 180L(Amines) was changed (2years → 36months). • Hexane 102L additional measurement range. • The shelf life of Hexane 103(Hydrocarbons (Lower class)) was changed (2years → 30months).
Page 14	<ul style="list-style-type: none"> • The shelf life of Hexylamine 180L(Amines) was changed (2years → 36months). • The Measuring range of Hydrazine 185 was changes (0.05-0.1 → 0.04-0.1). • The Note of Hydrazine 185 was changed (H → TH). • The shelf life of Hydrocarbons (Lower class) 103 was changed (2years → 30months). • The shelf life of Hydrogen fluoride 17L was changed (2years → 30months).
Page 15	<ul style="list-style-type: none"> • The shelf life of Isobutane 103(Hydrocarbons (Lower class)) was changed (2years → 30months). • The Measuring range of Isobutyl acrylate 142L(Butyl acetate) was changes (2.6-78 → 5.5-165). • The stain colour term of Isobutyl acrylate 142L(Butyl acetate) was changed (Blackish brown → Blackish brown (Pale blue after few minutes)). • The Measuring range of Isobutyl alcohol 116 was changes (4-10 → 3.7-10). • The shelf life of Isopentane 103(Hydrocarbons (Lower class)) was changed (2years → 30months).
Page 16	<ul style="list-style-type: none"> • The shelf life of Isopropyl amine 180L(Amines) was changed (2years → 36months). • The Measuring range of Methanol 111 was changed (0.002-0.004% → 0.002-0.007%, 0.004-0.02% → 0.007-0.02%, 1.5-4.5% → 1.5-6.0%). • The Measuring range of Methanol 111LL was changes (20-56 → 20-62).
Page 17	<ul style="list-style-type: none"> • The shelf life of Methylamine 180L(Amines) was changed (2years → 36months). • The shelf life of Methyl bromide 136L was changed (2years → 27months). • The shelf life of Methyl bromide 136LA was changed (2years → 36months). • New tubes (No.166) were added to Methyl tert-butyl ether. • The Measuring range of Methylcyclohexanone 155 was changes (50-100 → 50-80). • The Measuring range of Methylene chloride 138 was changed (20-50 → 30-50).
Page 18	<ul style="list-style-type: none"> • The Note of Methyl hydrazine 185(Hydrazine) was changed (H → TH). • New tubes (No.166) were added to Methyl isothiocyanate. • New tubes (No.234L) were added to Methyl isothiocyanate. • The shelf life of N-Methyl morpholine 180L(Amines) was changed (2years → 36months). • The shelf life of Morpholine 180L(Amines) was changed (2years → 36months).
Page 19	<ul style="list-style-type: none"> • The Measuring range of Nitrogen oxides 11L was changes (0.04-0.08 → 0.03-0.06 , 0.08-0.2 → 0.06-0.2 , 5.0-16.5 → 5.0-14). • The shelf life of Pentachloroethane 133L(Tetrachloroethylene) was changed (2years → 30months). • The shelf life of Pentamethylenediamine 180L(Amines) was changed (2years → 36months) • The shelf life of n-Pentane 103(Hydrocarbons (Lower class)) was changed (2years → 30months).
Page 20	<ul style="list-style-type: none"> • The Measuring range of Phenol 60 was changes (0.4-1 → 0.12-1, 25-62.5 → 25-70, 62.5-187 → 70-183). • The shelf life of Phosphine 7H was changed (2years → 36months). • The shelf life of Propane 103(Hydrocarbons (Lower class)) was changed (2years → 30months).
Page 21	<ul style="list-style-type: none"> • The shelf life of Propylamine 180L(Amines) was changed (2years → 36months). • The shelf life of n-Propyl bromide 136LA(Methyl bromide) was changed (2years → 36months). • The shelf life of Propylene imine 180L(Amines) was changed (2years → 36months). • The Measuring range of Pyridine 182 was changed (14-35 → 14-36.4). • The Measuring range of Sulphur dioxide 5LC was changes (10-25 → 10-22).
Page 22	<ul style="list-style-type: none"> • The shelf life of 1,1,2,2-Tetrabromoethane 135L(1,1,1-Trichloroethane) was changed (2years → 27months). • The shelf life of 1,1,2,2-Tetrachloroethane 131L(Vinyl chloride) was changed (2years → 30months). • The shelf life of Tetrachloroethylene 133HA was changed (2years → 30months). • The Measuring range of Tetrachloroethylene 133M was changes (100-250 → 10-220). • The shelf life of Tetrachloroethylene 133M was changed (2years → 30months). • The shelf life of Tetrachloroethylene 133L was changed (2years → 30months). • The Measuring range of Tetrachloroethylene 133LL was changed (3.0-9.0 → 3.0-6.6). • The Measuring range of Tetrahydrofuran 159 was changes (20-50 → 25-50). • The shelf life of Tetramethylenediamine 180L(Amines) was changed (2years → 36months).

Page 23	<ul style="list-style-type: none"> • The Measuring range of Trichloroacetic acid 15L(Nitric acid) was changes (1-37.5 → 1-37). • The shelf life of 1,1,1-Trichloroethane 135L was changed (2years → 27months). • The Measuring range of Trichloroethylene 132M was changes (100-250 → 100-270). • The shelf life of Trichloroethylene 132M was changed (2years → 30months). • The Measuring range of Trichloroethylene 132L was changes (1-2 → 0.8-2, 25-70 → 25-90). • The shelf life of Trichloroethylene 132L was changed (2years → 30months). • The shelf life of 1,2,3-Trichloropropane 135L(1,1,1-Trichloroethane) was changed (2years → 27months).
Page 24	<ul style="list-style-type: none"> • The shelf life of Triethylamine 180L(Amines) was changed (2years → 36months). • The shelf life of Trimethylamine 180L(Amines) was changed (2years → 36months). • The Measuring range of Vinyl chloride 131LB was changes (0.25-1 → 0.4-1). • The Measuring range of Vinyl chloride 131L was changes (3-6.6 → 3-6.9). • The shelf life of Vinyl chloride 131L was changed (2years → 30months).
Page 25	<ul style="list-style-type: none"> • The shelf life of 1,3-Butadiene 174D was changed (2years → 30months). • The shelf life of Carbon dioxide 2D was changed (2years → 30months). • The shelf life of Chlorine 132D(Trichloroethylene) was changed (1years → 15months). • The information about 1,2-Dichloroethylene 174D(1,3-Butadiene) was changed as follows. <ul style="list-style-type: none"> - Shelf Life: (2years → 30months) - The name of substance was changed (1,2-Dichloroethylene → trans-1,2-Dichloroethylene) • The shelf life of 1,2-Dichloroethylene 132D(Trichloroethylene) was changed (1years → 15months). • The shelf life of Ethylene 174D(1,3-Butadiene) was changed (2years → 30months). • The shelf life of Hydrogen chloride 132D(Trichloroethylene) was changed (1years → 15months).
Page 26	<ul style="list-style-type: none"> • The shelf life of Isoprene 174D(1,3-Butadiene) was changed (2years → 30months). • The shelf life of Tetrachloroethylene 133D was changed (1years→ 15months). • The shelf life of Tetrachloroethylene 132D(Trichloroethylene) was changed (1years→ 15months). • The shelf life of Trichloroethylene 132D was changed (1years → 15months). • The shelf life of Vinyl chloride 174D(1,3-Butadiene) was changed (2years → 30months).
Page 27	<ul style="list-style-type: none"> • 30m Extension Hose additional Detector Tubes: Butyl acetate 142L • The Measuring range of Acetic acid 81L was changes (0.125-25.0 → 0.125-23.0). • The Measuring range of Ammonia 3La was changes (2.5-200 → 2.5-220). • The shelf life of Arsine 19LA was changed (2years → 27months). • The shelf life of 1,2-Dichloroethylene 139 was changed (2years → 30months). • The Measuring range of Ethylene oxide 163L was changes (0.4-350 → 0.4-550). • The Measuring range of Formaldehyde 91L was changed (0.1-40.0 → 0.1-45.0). • The Measuring range of Hexane 102L was changed (4-1200 → 3.5-1200). • The shelf life of Hydrocarbons(Lower class) 103 was changed (2years → 30months).
Page 28	<ul style="list-style-type: none"> • 30m Extension Hose additional Detector Tubes: Methyl tert-butyl ether 166 Methyl isothiocyanate 234L • The Measuring range of Methanol 111 was changed (0.002-4.5% → 0.002-6.0%). • The shelf life of Methyl bromide 136L was changed (2years → 27months). • The shelf life of Methyl bromide 136LA was changed (2years → 36months). • The Measuring range of Nitrogen oxides 11L was changes (0.04-16.5 → 0.03-14). • The Measuring range of Phenol 60 was changes (0.4-187 → 0.12-183). • The shelf life of Phosphine 7H was changed (2years → 36months). • The Measuring range of Sulphur dioxide 5LC was changes (0.1-25 → 0.1-22). • The Measuring range of Vinyl chloride 131LB was changes (0.25-70 → 0.4-70). • The information about Vinyl chloride 131L was changed as follows. <ul style="list-style-type: none"> - Measuring Range: (0.1-6.6 → 0.1-6.9) - Shelf Life: (2years → 30months)
Page 31	<ul style="list-style-type: none"> • The shelf life of Free residual chlorine 222 was changed (2years → 30months).
Page 32	<ul style="list-style-type: none"> • The shelf life of Carbon monoxide 1A was changed (2years → 36months). • The shelf life of Carbon dioxide 2A was changed (2years → 36months). • The shelf life of Water vapour 6AH was changed (2years → 36months). • The shelf life of Water vapour 6A was changed (2years → 36months). • The shelf life of Water vapour 6Ag was changed (2years → 36months). • The shelf life of Oil mist 109A was changed (2years → 30months).
Page 33	<ul style="list-style-type: none"> • The shelf life of Carbon monoxide 1A was changed (2years → 36months). • The shelf life of Carbon dioxide 2A was changed (2years → 36months). • The shelf life of Water vapour 6A was changed (2years → 36months).

Page 34	<ul style="list-style-type: none"> • The shelf life of Acetone 151TP was changed (2years → 27months). • No.3S was added to Ammonia. • The shelf life of Benzene 121P was changed (2years → 30months). • The shelf life of Benzene 121TP was changed (2years → 27months). • New tubes (No.13TP) were added to Carbon disulphide . • The shelf life of Chlorine 8TP was changed (2years → 30months). • New tubes (No.183TP) were added to N,N-Dimethylformamide and N,NDimethylacetamide. • The shelf life of Hydrogen fluoride 17TP was changed (2years → 30months). • No.4S was added to Hydrogen sulphide. • The shelf life of Isopropyl alcohol 113TP was changed (2years → 36months). • The shelf life of Nitrogen dioxide 9P was changed (2years → 30months). • No.124S was added to Styrene. • The shelf life of Toluene 122TP was changed (2years → 36months).
Page 35	<ul style="list-style-type: none"> • Automatic Air Sampling Pump model change (GSP-300FT-2 → GSP-501FT) • A new page was added for the information about Sorbent tubes : 251S-20, 251S2-20, 258-20, 258A-20, 258S2-20, 252S-20, 252S2-20, 252S3-20, 252S4-20
Page 36-40	<ul style="list-style-type: none"> • Changes in the index according to the above changes.
All pages	<ul style="list-style-type: none"> • Shelf life was converted from years to months.





For all types of gas and vapour SINCE 1970



GASTEC CORPORATION

8-8-6 Fukayanaka, Ayase-City, Kanagawa 252-1195, Japan

Tel: +81(0)467-79-3910 Fax: +81(0)467-79-3979

URL: <https://www.gastec.co.jp/>

As a result of Gastec's commitment to continual improvement,
specifications are subject to change without notice.

CA00DTE23 23D2D